

Instruction Manual

ETX OBSERVER SERIES



ETX-125



ETX-90



ETX-80



WARNING!

Never use a Meade® ETX telescope to look at the Sun! Looking at or near the Sun will cause instant and irreversible damage to your eye. Eye damage is often painless, so there is no warning to the observer that damage has occurred until it is too late. Do not point the telescope at or near the Sun. Do not look through the telescope or Red Dot Finder as it is moving. Children should always have adult supervision while observing.

BATTERY SAFETY INSTRUCTIONS:

- Always purchase the correct size and grade of battery: "AA-type" Alkaline batteries (ANSI 15A, 15AC/ IEC LR6).
- Always replace the whole set of batteries at one time, taking care not to mix old and new ones, or batteries of different types.
- Clean the battery contacts and also those of the device prior to battery installation.
- Ensure the batteries are installed correctly with regard to polarity (+ and -).
- Remove batteries from equipment which is not to be used for an extended period of time.
- Remove used batteries promptly.
- Never attempt to recharge primary batteries as this may cause leakage, fire, or explosion.
- Never short-circuit batteries as this may lead to high temperatures, leakage, or explosion.
- Never heat batteries in order to revive them.
- Remember to switch off devices after use.
- Keep batteries out of the reach of children; small batteries may be ingested.
- Seek medical advice immediately if a battery has been swallowed.

Caution: If batteries or parts are swallowed, see a doctor immediately.

CONTENTS

Introduction

The ETX Observer Telescope	4
----------------------------	---

Getting Started

Assembling and Using the ETX Telescope

Assembling the Tripod	5
Mounting the Telescope	6
Installing the Batteries	6
Secure Vertical and Horizontal Locks	7
Attaching Accessories	7
Your Telescope is now Fully Assembled	7
Using the Red Dot Finder	8
Adjusting the Red Dot Finder	9
Aligning the ETX	9
The ETX Home Position	9
Finding North	10
Moving Through AudioStar's Menus	10
Initializing AudioStar	10
Easy (Two-Star) Align	10
How to Perform the Easy Align Procedure	12
Go To Saturn	13
Using the Guided Tour	13

ETX Observer Key Features

Telescope

ETX 80 Key Features Identified on the Telescope	14
Key Features Explained	16
ETX 90 & 125 Key Features Identified on the Telescope	18
Key Features Explained	20

AudioStar Handbox – Basic Usage

Buttons, Display and their functions	22
Observing Using AudioStar's Keys	24
Observe the Moon	25
Terrestrial Observing	25
ETX Observer Tips	25

AudioStar Operation

AudioStar Navigation Exercise	26
Entering Data into AudioStar	27
Guided Tour Menu	27
Object Menu	28
AudioStar Menu Tree	26
Event Menu	29
Glossary Menu	30
Utilities Menu	30

© The name "Meade," "AudioStar" and the Meade logo are trademarks registered with the U.S. Patent and Trademark Office and in principal countries throughout the world. "ETX 90", "ETX 125", "ETX 80", and "Tonight's Best" are trademarks of Meade Instruments Corp.

Patents:

US 7,277,223, US 7,079,317, US 7,092,156

US 6,304,376, US 6,369,942, US 6,392,799

© 2016 Meade Instruments Corp.

Setup Menu	31
------------	----

Advanced AudioStar Features

Adding Observing Sites	34
Finding Objects Not In the Database	34
GoTo a User-entered Object	34
Observing Satellites	36
How to Create Your Own Guided Tour	36
Writing a Tour	37
Landmarks	40
Identify	41
Two-Star Alt/Az Alignment	42
One-Star Alt/Az Alignment	43
Browse	43

Optional MEADE® Accessories

Choosing Eyepieces	44
Power Supplies	45
Other Accessories	45

Maintenance

Basic Maintenance	47
Storage and Transportation	47
Inspecting the Optics	48
Trouble Shooting	48

Appendix A:

Training the Drive	50
--------------------	----

Appendix B:

Basic Astronomy	51
-----------------	----

Appendix C:

Specifications	53
----------------	----

Appendix D:

Equatorial (Polar) Alignment	56
------------------------------	----

Appendix E:

Latitude Chart	61
----------------	----

Appendix F:

Optical Systems	62
-----------------	----

Recycling:

How to recycle	63
----------------	----

Meade Warranty

One Year Limited Warranty	64
---------------------------	----

Meade Customer Service

How to get in contact	65
-----------------------	----

INTRODUCTION

The ETX Observer Telescope

An advanced, computer-controlled telescope system

Congratulations on receiving your new ETX Observer telescope! You'll find that this telescope system has all you need to explore the Universe we live in. Meade's concept was to create a telescope that would be simple enough for anyone to use, yet capable enough for the experienced amateur to stretch their knowledge and skills. With the ETX's advanced set of features, you will have plenty of room to learn and expand your interest in astronomy and not out grow your telescope. Here are a few of the features that set the Meade ETX Observer telescope system apart from all others.

Optics: ETX telescope optics produce superlative, optical performance and resolution. Optics so high in contrast, image brightness, and resolution that the ETX optical systems often outperform many telescopes of larger apertures. With the ETX 80 & 90's new removable optical tube assembly, you can now take these optical tubes with you wherever your adventures take you. Mount the 80mm or 90mm directly to any photo tripod using 1/4-20 mounting screws, and observe more of your adventure from afar.

Mechanics: Fork Mount with standard-equipment dual-axis drive system and AudioStar Controller. The rigid fork mounting of the ETX Observer telescope includes high-torque DC motors on both telescope axes.

Computer: The AudioStar handbox gives you complete control of your ETX system from the palm of your hand. With a database of over 30,000 objects, you will never run out of things to explore. The enhanced AudioStar hand controller adds Meade's Astronomer Inside audio content. Listen through its built-in speaker as it reads you fun and informative descriptions of over 500 night sky objects as you actually view them in the eyepiece. A quick and easy 2-minute alignment on the night sky allows automatic tracking of astronomical objects.

If you are like us, you can't wait to get outside under a dark sky to try out your new ETX telescope. We have provided a Getting Started Guide that will get you up and running in the shortest amount of time possible. After your first experience, please sit down with this manual and read about all the advanced features that are available to you with this telescope system. We are confident that the ETX will keep you fascinated with the Universe and entertained for many years to come.

Clear Skies,

The people at Meade



GETTING STARTED

You may want to perform the ETX telescope assembly indoors in the light so that you become familiar with the parts and operation before moving the telescope outside into the dark for observing. Just follow the simple steps below and you will be up and running before you know it. It is best to set up the telescope in twilight or before sunset the first time you use it.

Take the telescope and tripod outside. Set the telescope in a large open area where you can see lots of sky. Don't setup right next to a building or a wall. Make sure the ground is stable and is approximately level. It is best to set up the scope away from bright nighttime lighting. Bright lights will spoil your night vision and impede your ability to see the sky.

Please note the ETX 80 & ETX 90/125 have different tripods. As a result, there are subtle differences when setting up the tripods and installing the telescope mount. Follow the steps below noting when there are differences between the two telescope models and proceed accordingly.

Assembling the Tripod

1 Remove the field tripod from the shipping carton. Stand the tripod vertically with the tripod feet down and with the tripod still fully collapsed. Grasp two of the tripod legs and, with the full weight of the tripod on the third leg, gently pull the legs apart to a fully open position. ETX 80 users may need to loosen the black lock knob located on the center shaft of the tripod. Rotate counter clockwise to loosen if needed.

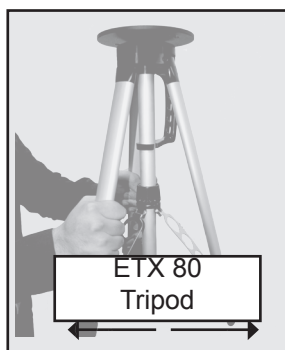

2 ETX 80 USERS ONLY: Loosen the leg lock latches on each leg (three per leg) and extend each leg segment until the top of the tripod is level and at the desired height. Re-lock the leg lock latches to secure each leg segment.

ETX 90/125 USERS ONLY: Loosen the lock knobs on each leg (one per leg) near the foot

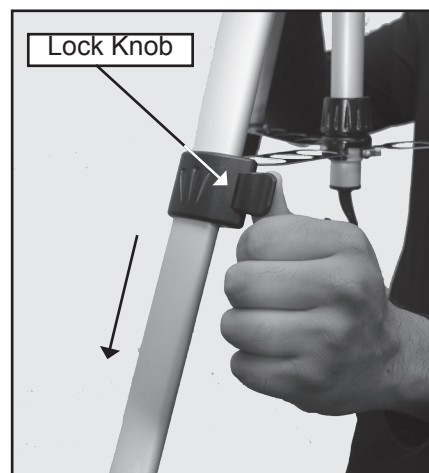

of each tripod leg. Use the lock knobs to vary the height of the inner, extend-able tripod leg sections. Tighten the locks to a firm feel only; do not over-tighten.

3 ETX 80 USERS ONLY: Tighten the center column lock knob by rotating it clockwise until firm. This lock knob prevents the tripod legs from being collapsed inward into the storage position.

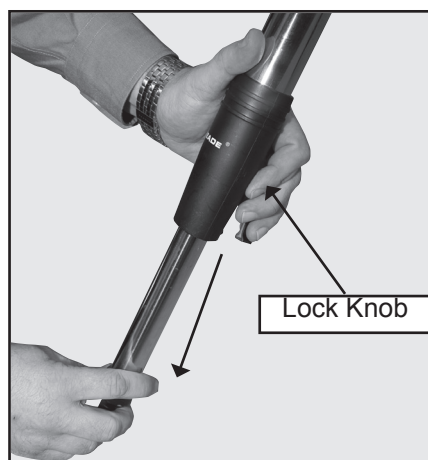

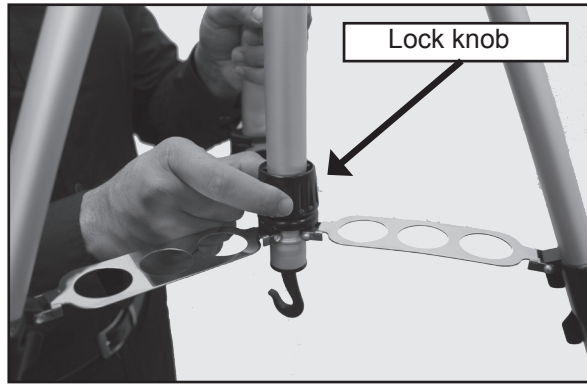

ETX 90/125 USERS ONLY: Remove the end nut from the spreader shaft and slide the spreader in between the telescope legs. Attach the end nut and hand tighten until the telescope legs are held snugly in the most spread position. Position the tripod where you want the telescope to be and check that the top of the tripod is approximately level. Use the included bubble level/compass to level the tripod head.

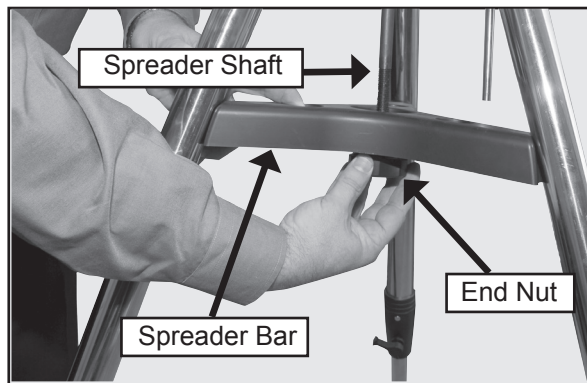

Mounting the Telescope

4 ETX 80 USERS ONLY: Thread the supplied bolts about two or three turns through the underside of the telescope base. Line up the bolts over the key-like holes on the top of the tripod and slide the bolts into the holes. Rotate the telescope counter-clockwise

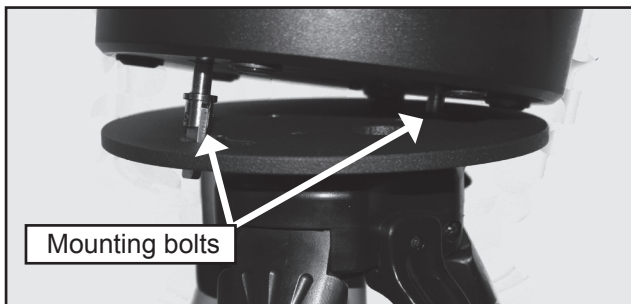

until the bolts fit into the hole bays. Then, reach under the tripod base and tighten the bolts to a firm feel.

ETX 90/125 USERS ONLY: On the tripod, loosen the latitude control knob and lift up the tilt-plate so that you can easily access the underside of the plate. Re-lock the latitude control knob, so the assembly doesn't slip while you are attaching the telescope.

Take the ETX 90/125 from its packaging and line up the mounting holes on the base of the telescope with the tripod attachment knobs. Thread both attachment knobs into the base of the telescope. Tighten to a firm feel only.

Unlock the latitude control knob and lower the tilt-plate until it is level (push the tilt-plate down until it stops; this is the level position). Lock the latitude control knob.

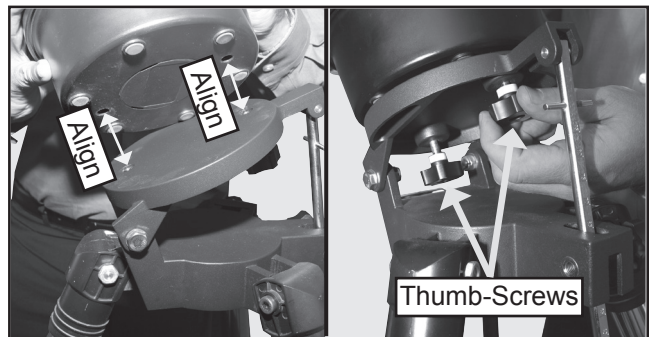
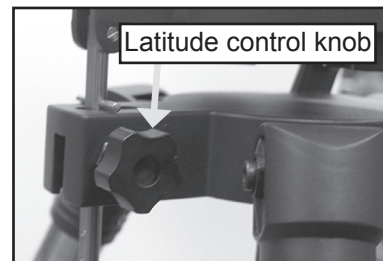

Installing the Batteries

5 Lift the battery cover located in between the mount fork arms. Gently remove the battery holder from the compartment so you don't accidentally pull out the wires attached to the holder. Insert 6 user supplied "AA" batteries (ETX125 uses 8) in the holder. Refer to the diagram on the holder to orient the batteries properly. Replace the holder back into the battery

compartment and replace the lid.

CAUTION: Use care to install batteries as indicated by the battery compartment. Follow battery manufacturer's precautions. Do not install batteries backwards or mix new and used batteries. Do not mix battery types. If these precautions are not followed, batteries may explode, catch fire, or leak. Improperly installed batteries void your Meade warranty. Always remove the batteries if they will not be used for a long period of time.



Secure Vertical and Horizontal Locks

6 Tighten the vertical and horizontal locks to a “firm feel” only, do not over-tighten. These locks engage the telescope motors so the ETX can be moved using the AudioStar hand controller.

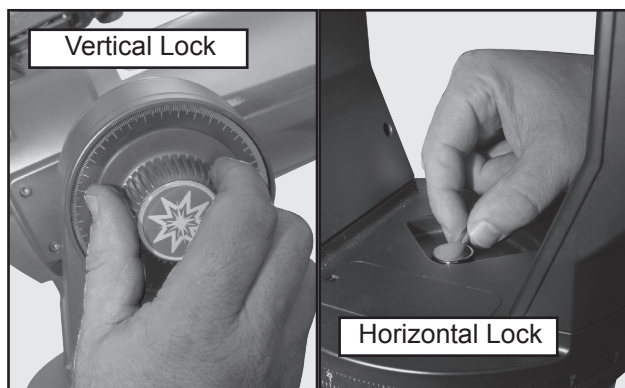

Attaching Accessories

7 Be sure the telescope master power switch is in the off position. Remove the AudioStar handbox and the coiled interface cable from the packing materials. Plug one end into the HBX port of the control panel and plug the other end into the Handbox port on the AudioStar handbox.



8 Place the 26mm eyepiece into the eyepiece holder on the telescope and tighten the attachment thumbscrew to a “firm feel” only.



9 Slide the Red Dot Viewfinder into the slotted holder on the top surface telescope and tighten the attachment thumbscrew to a “firm feel” only.

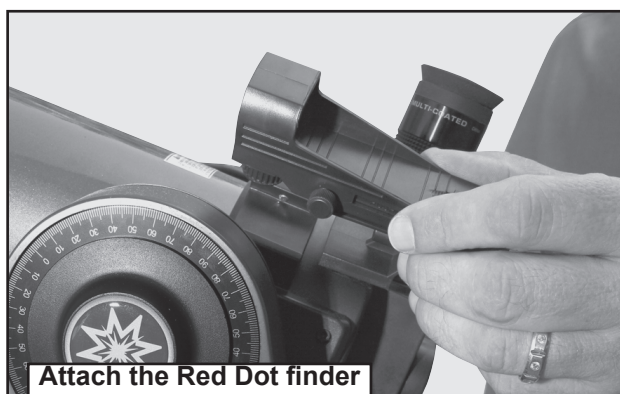

Your Telescope is now Fully Assembled.



Using the ETX Observer.

10 Now remove the dust cover from the front of the telescope tube. Be careful not to touch the glass lens.

11 Flip the Power Switch on the computer control panel to the ON position. The copyright message lights on AudioStar's LCD display.

12 "Press 0 to align or Mode for Menu" displays. You can use the Arrow keys to slew (move) the telescope up, down, right, or left. To change the telescope's slew speed, press a Number key. "9" is the fastest speed and "1" is the slowest speed. See page 24 for more details. Or you can Press "0" to begin Easy Alignment.

See page 11 for more information on AudioStar.

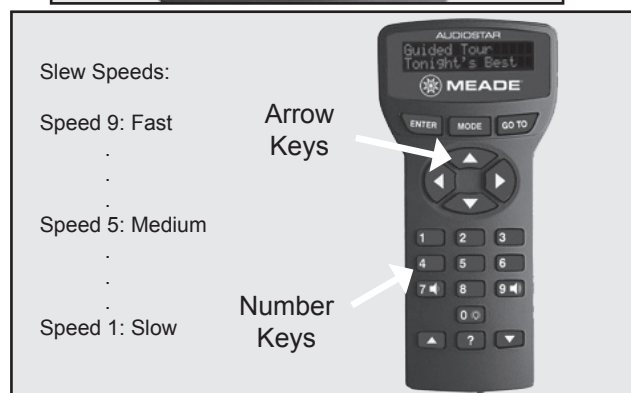

Using the Red Dot Finder

Because your telescope has so much magnification, its field of view is very small. This can make it hard to know exactly where your telescope is pointing by simply looking at it. To help you point the telescope quickly and accurately, the ETX has a 1X Red Dot Viewfinder.



The Red Dot Finder will aid you in pointing your telescope easily. It works much like a fighter pilot's heads-up display. To turn on the Red Dot Finder, carefully rotate the power switch until you feel it click on. Turning further clockwise will increase the dot brightness. Adjust the dot to the minimum brightness where it can be easily seen. This will extend its battery life and make it easier to see faint stars in the background.

Look through the finder's glass window. You will see a

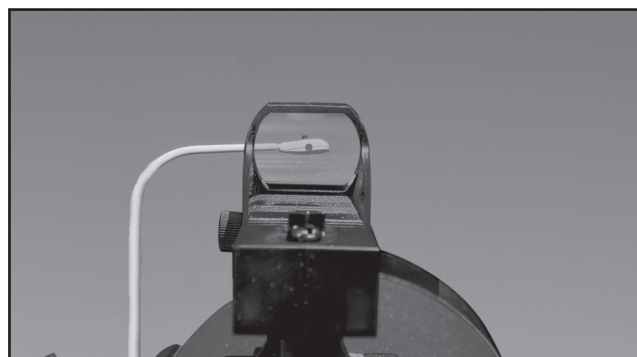

red dot superimposed on your view. Using the direction keys on the handbox, move the telescope until the red dot is on the target you want to view in the eyepiece. As you get close to your target, select a moderately low speed, like speed 5, and move the scope to center your target as you look through the telescope eyepiece. This a great way to get used to finding the movement keys without removing your eye from the eyepiece.

Adjusting the Red Dot Finder

Now, without moving the telescope, adjust the indicated thumb screws until you have put the red dot on the object at which you were looking. It's that simple.

Now use the hand controller to put the laser dot on a new target. Check to see that the desired target is in the eyepiece and adjust the focus knob until the object is in focus.

NOTE: Be sure to turn off red dot when not in use.

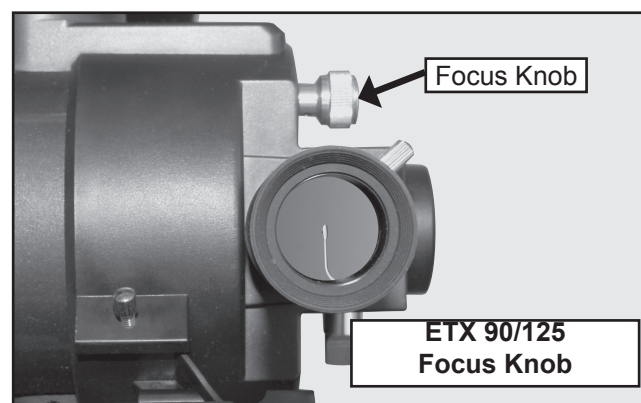
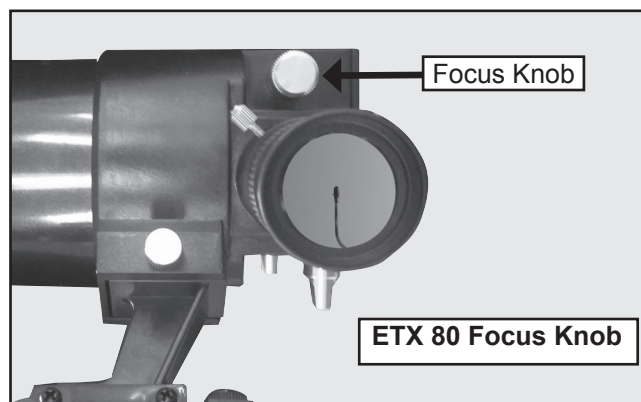
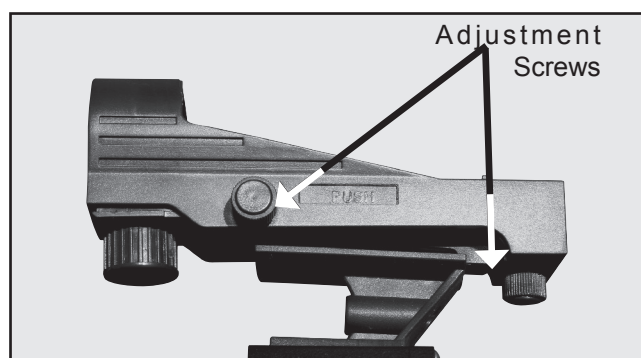

Aligning the ETX

To automatically track and locate objects in the night sky, the ETX must first be aligned on the sky. It is best to set up the telescope in twilight or before sunset the first time you use the ETX. Setup the telescope in a large open area where you can see lots of the night sky. Make sure the ground is stable and approximately level. It is best to setup the scope away from bright nighttime lighting. Bright lights will spoil your night vision and impede your ability to see the sky.

The ETX "Alt/Az" Home Position

Once the ETX is fully assembled, you will first need to initialize AudioStar, set the telescope into the home position, and perform the Easy Alignment in order for the ETX to successfully locate celestial objects.

The home position for the ETX is with the telescope optical tube level and pointed in the direction of either True North or Magnetic North. See Figure 1. Correct telescope placement in the home position will ensure the successful location of the alignment stars.

a2

Finding North

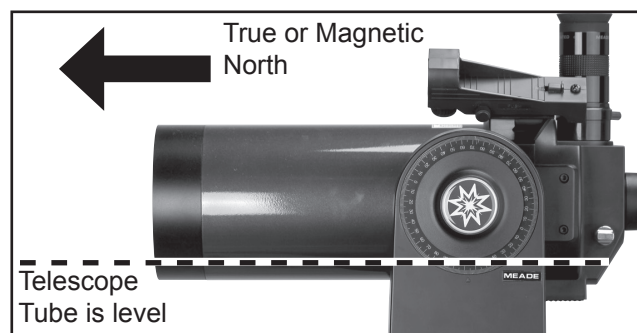

Figure 1: Alt/Az Home Position

Method #1: Finding True North using the North Star (Polaris): To find True North, insert the bubble level/compass into the eyepiece holder and point the telescope tube towards Magnetic North. See the "Locating Polaris" diagram above, which directs you to the North Star (Polaris). Looking towards Magnetic North locate the Big Dipper; follow the two stars in the bowl of the Big Dipper to the North Star. With the tube still level, rotate it so that it points in the direction of the North Star. Lock the horizontal lock. The tube is pointing True North and now in the Alt/Az home position.

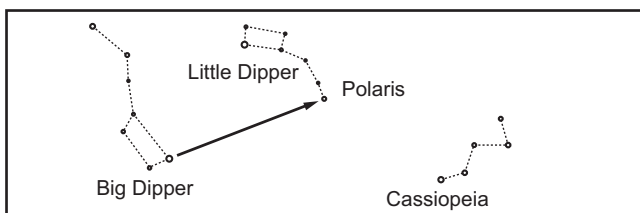

Figure 2: Locating Polaris

When performing the Easy Alignment, select 1=True when prompted. See Figure 3b.

Method #2: Finding Magnetic North using a Compass: True North and Magnetic North differ and will vary from location to location. In order to correctly compensate for these differences you would need to know the magnetic declination adjustment based on your location. However, Meade has simplified the alignment routine and AudioStar now allows you to point the telescope directly at your local magnetic North as a starting point for the alignment.

Using the included magnetic compass, determine the direction of magnetic North. The red arrow on the compass will point toward magnetic North. **Note:** Stand

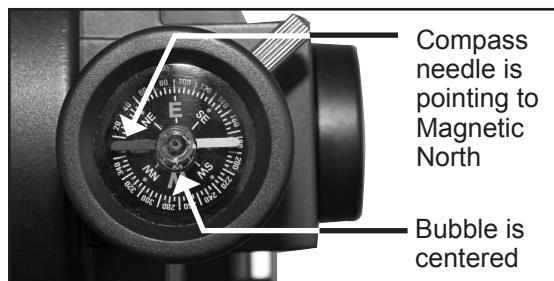

Figure 3a: Bubble Level/Compass



Figure 3b: Choosing North Method

away from large metal objects as this will interfere with the compass reading.

Now unlock the horizontal lock knob and rotate the mount until the OTA points toward magnetic North.

Lock the horizontal lock. The tube should now be level and pointing toward magnetic North. The ETX is now in the Alt/Az home position.

When performing the Easy Alignment, select 2=Compass when prompted. See Figure 3b.

Moving Through AudioStar's Menus

The AudioStar database is organized in levels for quick and easy navigation.

- Press ENTER to go deeper into AudioStar's menu levels.
- Press MODE to move back toward the top menu level. This is similar to a back button.
- Press GOTO to move to objects in the database. Use this after you perform a night sky alignment and have selected an object from the Audiostar database.
- Press the central Arrow keys to electronically move the telescope in a specific direction. Or use the central Arrow keys and number keys to enter characters and digits when inputting information.
- Press the bottom Scroll keys to move up and down through the options available for each level.

Initializing AudioStar

This section describes how to initialize AudioStar. Perform this procedure the first time you use AudioStar or after performing a RESET (see "RESET" page 33).

1. Verify that AudioStar is properly connected to your telescope. See "Getting Started" page 7.
2. Turn the telescope power switch to the ON position.

The AudioStar beeps and the display screen is activated. Then AudioStar takes a few moments to start up the system.

3. “Press 0 to Align or Mode for Menu” displays. Press 0 to align your telescope using the “Easy Align” method, see “Easy (Two-Star) Align” on page 11. To skip the alignment process and access the AudioStar menus, press the Mode key instead.
4. The telescope then tests the motor function of the telescope by moving a small amount in the horizontal and vertical directions.
5. Set Your Location or Zip Code: The Location screen displays. This screen asks you if you wish to choose either the zip code of your observing location or the location (i.e., entering the city and state or country of your observing location). Press “1” to select the zip code option or “2” to enter the city and state.

Note: The location settings (country/state/ province and city, or zip code) are only asked for the first time you turn on the control panel. If you wish to change this setting later on, use the Site menu. See SITE, page 32 for more information.

- A. If you chose the zip code option, the left most “0” is highlighted. Use the Number keys to enter the digits. As you enter a digit, the next digit to the right will be highlighted. Enter the next digit. Repeat this process until all 5 digits of your zip code are entered. Press ENTER.
- B. If you chose the location option, the next screen asks for the country or state/province (listed alphabetically) of the observing site.
 - i. Use the Scroll keys to scroll through the list of countries, states, and provinces. Press ENTER when the correct location displays.
 - ii. The next screen asks for the city (listed alphabetically) closest to the observing site. Use the Scroll keys to scroll through the list of cities. Press ENTER when the correct city appears on screen.

6. The next screen requests the status of Daylight Savings Time. If Daylight Savings Time is active, press the “1” key. If Daylight Savings Time is not active, press the “2” key.

Note: Daylight Savings Time may be referred to by a different name in various areas of the

world.

7. AudioStar then asks for the Telescope Model. Using the scroll keys (Pg. 22, Fig. 19a, 7) on the AudioStar locate the model of your telescope and press enter.
8. System initialization is now complete and AudioStar enters into the Easy Alignment routine. See “Easy (Two-Star) Alignment” for performing an alignment on the night sky. If you do not wish to begin an alignment on the night sky, press the MODE key to exit to the main AudioStar menu.

Easy (Two-Star) Align

The fastest and easiest way to locate objects with AudioStar’s GO TO capabilities is to use Easy Align.

AudioStar automatically picks two stars from its database for the Easy Align procedure. During this procedure, AudioStar slews the telescope to a first alignment star. The user is asked to verify that the telescope is pointed at the chosen star and then prompted to center the star in the eyepiece. The process is repeated with a second star to complete the alignment.

Note: Before aligning the telescope, first verify that “INITIALIZING AudioStar”, page 11, has been performed. See “Moving through AudioStar’s Menus”, page 10, for a description

Which One’s the Alignment Star?

If you’re not familiar with objects in the night sky, how can you be sure if the star in your eyepiece is really the alignment star?

The rule of thumb is that an alignment star is usually the brightest star in that area of the sky. If you perform a GoTo to an alignment star and you’re not sure if you have located the alignment star or it isn’t in the eyepiece, look through your viewfinder. When you view an alignment star in the viewfinder, it stands out dramatically from the rest of the stars in that portion of the sky.

The viewfinder will help you locate a star more quickly than the eyepiece. Using AudioStar, set the slew speed to 6 (press Number key 6) or higher and use the Arrow keys to center the alignment star in the viewfinder. If your viewfinder has been aligned with the telescope, the alignment star should now be in the eyepiece. Set the slew speed to 4 or less and center the star in the eyepiece. Also see the Spiral Search tip, next page.

of how AudioStar's keys operate.

Hint: It is best to verify the AudioStar's site information before performing any night sky alignment. Check the date, time, daylight savings, location, and telescope model before each alignment. If any of these are incorrect, the ETX will not operate correctly.

How to perform the Easy Align Procedure

If you have just powered on the telescope, follow the procedures listed in "Initializing AudioStar" on page 11. When completed, continue on to the steps below to perform the Easy Alignment procedure. If the telescope is already powered on and the correct site location, date, time, daylight savings, and telescope model have already been entered, the Easy Alignment can be started by selecting in the menu Setup: Align: Easy and following the steps below.

1. When the Easy Alignment procedure is selected in the AudioStar's setup menu. See page 9, "The ETX Alt/Az Home Position" for a description on placing the ETX telescope into the home position.

Note: The easiest way to set the telescope in

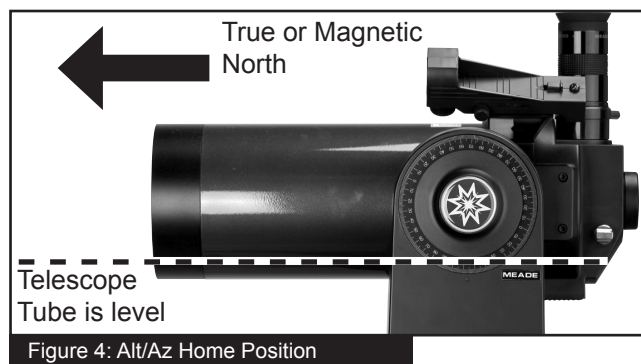

the home position is using the Magnetic North method. Follow the steps on page 10 "Finding Magnetic North using a Compass.

2. **Star Alignment** - The AudioStar then chooses

two stars to align upon. When the telescope slews to the first star for alignment, it may not appear in the field of view in the eyepiece. The alignment star should be easily recognized and be the brightest star in the area of the sky where the telescope is pointing.

While looking through the red dot finder, use the Arrow Keys to move the telescope to place the red dot on the top of the brightest nearby star. Now look through the eyepiece and use the Arrow Keys to move the star to the center of the eyepiece field. Press ENTER.

If that area of the sky is obscured by an object, you can prompt AudioStar to choose an alternate star by pressing either one of the two Scroll Keys. Repeat procedure for the second alignment star.

When the procedure is performed correctly, "Alignment Successful" displays. If AudioStar does not display this message, perform this procedure again.

Note: AudioStar locates alignment stars based on the date, time, and location entered. The alignment stars may change from night to night. All that is required is for the observer to precisely center the selected stars in the eyepiece when prompted.

Hint: The GO TO key also allows you to perform a "spiral search". A spiral search is useful when the telescope slews to an object, but that object is not visible in the eyepiece after the telescope finishes its search. (This sometimes occurs during an alignment procedure.) Press GO TO when the slew is finished and the telescope starts slewing in a spiral pattern at a very slow speed around the search area. Look through the eyepiece and when the object does become visible, press MODE to stop the spiral search. Then use the Arrow keys to center the object.

Go To Saturn

After performing the Easy Alignment procedure, the motor drive begins operating and the telescope is aligned for a night of viewing. Objects in the eyepiece should maintain their position even though the Earth is rotating beneath the stars.

Important Note: Once aligned, only use the GO TO or Arrow keys to move the telescope. Do not move the telescope manually, or alignment will be lost.

Once the telescope is aligned, you may choose and “Go To” any object listed in AudioStar’s Object menu. This exercise demonstrates how to select one such celestial object, the planet Saturn, for viewing from the Object menu.

Note: Saturn is not visible the entire year and you may need to choose another object from AudioStar’s database; however, the procedure, as described below, remains the same.

1. After the telescope is aligned, “Select Item: Object” displays. Press ENTER.
2. “Object: Solar System” displays. Press ENTER.
3. “Solar System: Mercury” displays. Keep pressing the Scroll Down key until “Solar System: Saturn” displays.
4. Press ENTER. “Calculating” displays. Then “Saturn” and a set of coordinates displays. Note that Saturn’s (and other planets’) coordinates change throughout the year.
5. Press GO TO. “Saturn: Slewing...” displays and the telescope slews until it finds Saturn. You may need to use the Arrow keys to center Saturn precisely in the eyepiece. AudioStar then automatically moves the telescope so that it “tracks” Saturn (or whatever other object you may have chosen); i.e., Saturn remains centered in the eyepiece.

After you Go To Saturn, practice the Go To feature with other objects in the Object menu lists. For example, during Winter, choose M42,

the Orion nebula, from the Messier list. Or in the summer, choose the Dumbbell nebula from the Deep Sky, Named Objects list.

Using the Guided Tour

This example demonstrates using “Tonight’s Best” Guided Tour.

1. After observing Saturn, press mode three times so that “Select Item: Object” displays again.
2. Press the Scroll Down key twice. “Select Item: Guided Tour” displays.
3. Press ENTER. “Guided Tour: Tonight’s Best” displays. Press ENTER.

If you wish to try out other Guided Tours, press the Scroll Down key to scroll through other tour choices. When the tour you wish to select displays, press ENTER.

4. “Tonight’s Best: Searching...” displays. After calculating, “Tonight’s Best: Jupiter” displays.

Note: Different objects may be displayed on a tour list on any given night.

Press ENTER to display information about the object. Press GO TO to move the telescope to the object.

5. Press MODE to return to the Tour list. Press the Scroll keys to scroll through the list. Press ENTER when you find the next object you wish to observe.
6. Press and hold down MODE for two seconds to leave the Guided Tour menu.

The ETX 80 Telescope - Key Features

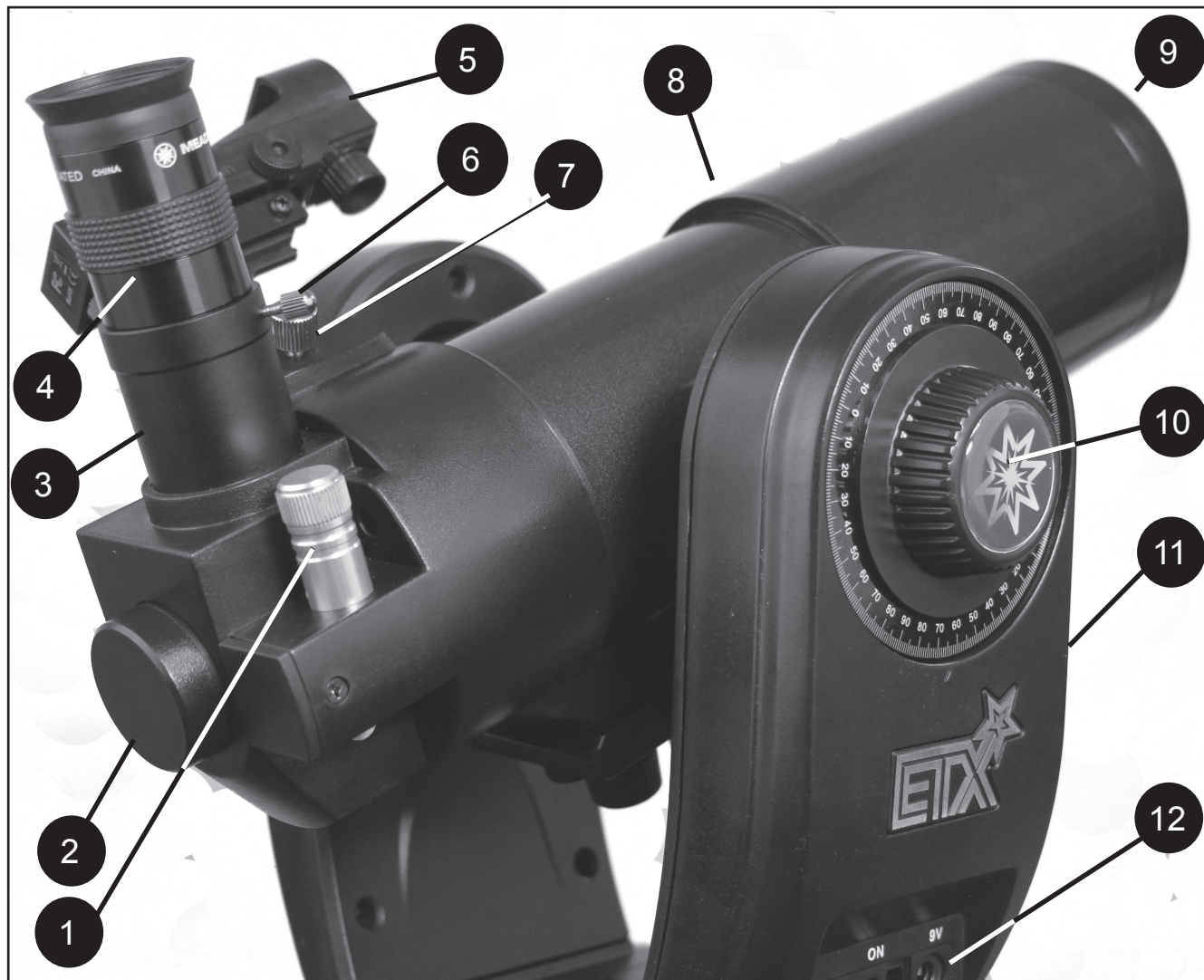

- | | |
|-------------------------------|----------------------------------|
| 1. Focus knob | 7. Red dot viewfinder thumbscrew |
| 2. Rear photo port | 8. Optical tube |
| 3. Eyepiece holder | 9. Dust cover (not visible) |
| 4. Eyepiece | 10. Vertical lock knob |
| 5. Red dot viewfinder | 11. Fork arm |
| 6. Eyepiece holder thumbscrew | 12. Computer control panel |

Figure 5. ETX 80 Right Side

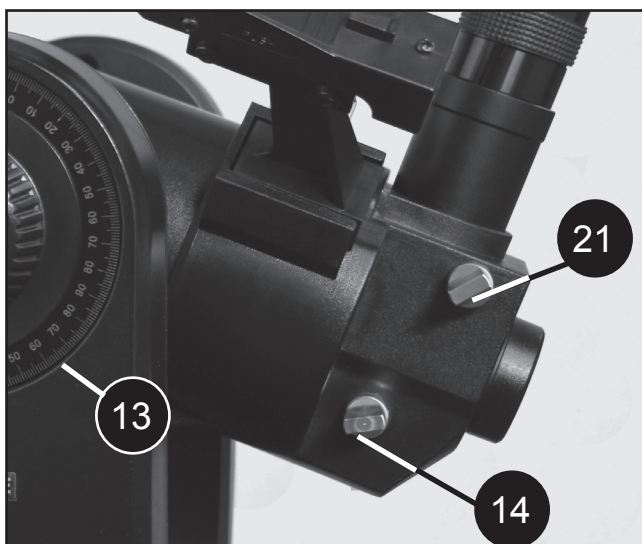

Figure 6: ETX 80 Left Side

- 13. Vertical setting circle
- 14. 90° flip mirror
- 15. Front lens
- 16. OTA mounting thumbscrews(2)
- 17. Bubble level/compass
- 18. Horizontal lock knob
- 19. Battery compartment
- 20. Horizontal setting circle
- 21. 2x flip-Barlow



Figure 7: ETX 80 Dust Cap

- 5a. On/Off Switch
- 5b. Red dot finder adjustment knobs

- 12a. Handbox (HBX) port
- 12b. Power LED
- 12c. On/Off switch
- 12d. Auxiliary (AUX) port
- 12e. 9 volt Power port (12v compatible)

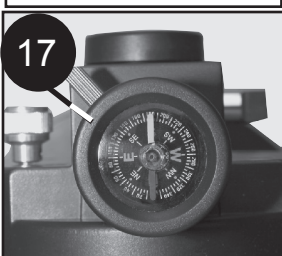

Figure 9: ETX 80 Bubble Level

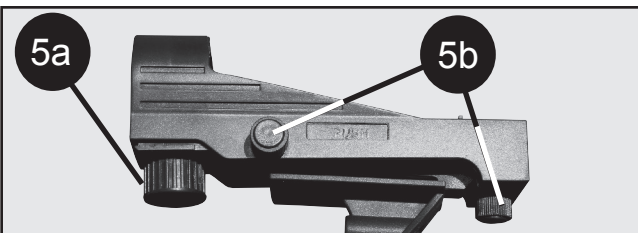

Figure 10: ETX 80 Red Dot

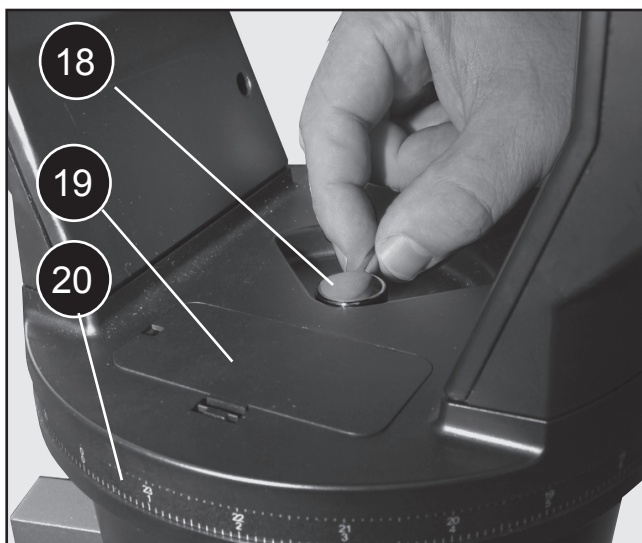

Figure 8: ETX 80 Top of Base

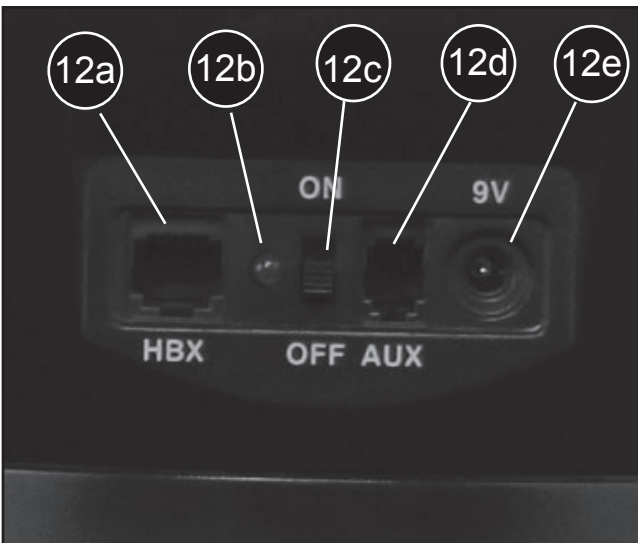

Figure 11: ETX 80 Control Panel

1. **Focus knob:** Moves the telescope's front lens in a finely-controlled motion to achieve precise image focus. The ETX 80 telescope can be focused on objects from a distance of about 15 ft to infinity. Rotate the focus knob clockwise to focus on distant object. Meade makes a complete line of accessories to enable you to get the most fun and performance from your ETX telescope. No matter what you want to accomplish, we have the equipment to help you get there.
2. **Rear photo port:** Attach any 35mm camera with a removable lens to this port using an optional #64 ST T-Adapter or attach the #933 45° Erecting Prism for correctly oriented images through the eyepiece. See OPTIONAL ACCESSORIES, page 44.
3. **Eyepiece holder:** Holds the eyepiece upright for easy viewing.
4. **Eyepiece:** Place the supplied 26mm eyepiece into the 90° Eyepiece Holder (Pg 14, Fig. 5, 3) and tighten in place with thumbscrew (Pg 14, Fig. 5, 6). Change the eyepiece to a lower focal length eyepiece and zoom in on your target.
5. **Red dot viewfinder:** Provides an easier way to locate objects than in the main telescope eyepiece which has a narrower field of view.
 - 5a. **Red dot viewfinder On/off switch:** Turn the knob located underneath the viewfinder lens to turn on/off the red dot and change the intensity of the dot. (**Note:** Be sure to turn off the red dot when not in use.)
 - 5b. **Red dot viewfinder adjustment knobs:** Use these adjustment knobs to align the red dot viewfinder to the ETX optical tube. Locate an object in the telescope eyepiece and use these adjustment knobs to move the red dot until its over the same object.
6. **Eyepiece holder thumbscrew:** Locks the eyepiece in place. Insert the eyepiece in the eyepiece holder and tighten this screw until firm.
7. **Red dot viewfinder thumbscrew:** Locks the viewfinder in place. Insert the red dot viewfinder in its mounting bracket and tighten this screw until firm.
8. **Optical tube:** The main optical component that gathers the light from distant objects and brings this light to a focus for examination with the eyepiece.
9. **Dust Cover:** Unthread the dust cover counterclockwise from the front lens of the telescope before observing.
10. **Vertical lock knob:** Controls the manual vertical movement of the telescope. Turning the vertical lock counterclockwise unlocks the telescope enabling it to be freely rotated by hand about the vertical axis. Turning the vertical lock clockwise (to a firm feel only) prevents the telescope from being moved manually, but engages the vertical motor drive clutch for AudioStar operation. When polar aligned, the vertical lock serves as the Declination or Dec. lock.

Note: The vertical lock knob is a knurled knob located on the fork arm to the right of the focus knob (Pg 15, Fig. 6, 13). Mounted beneath the knob is a circular scale without numbers. Do not confuse this scale with the Dec. setting circle located on the opposite fork arm which has a numbered scale used to locate astronomical objects manually.
11. **Fork arm:** Holds the optical tube in place.
12. **Computer control panel:** (see Pg 15, Fig. 11).
 - 12a. **Handbox (HBX) port:** Plug the AudioStar handbox into this port.
 - 12b. **Power LED:** The red power indicator light illuminates when power is supplied to the telescope's motor drive.
 - 12c. **On/off switch:** Turns the Computer Control Panel and AudioStar handbox ON or OFF.
 - 12d. **Auxiliary (AUX) port:** Provides connection for current and future Meade accessories. See OPTIONAL ACCESSORIES, page 44.
 - 12e. **9 volt power port:** Designed to accept 9 to 12 volt external power including the Meade #07584 12V AC adapter and LXPS power supply. See OPTIONAL ACCESSORIES on page 44.

13. Vertical setting circle: (on left fork arm): See page 58 for detailed information.

14. 90 degree flip mirror: ETX telescopes include an internal mirror. With the flip-mirror control in the “up” position light is diverted to the eyepiece. With the flip-mirror control in the “down” position light proceeds straight out the photo port for photography.

Note: The flip-mirror control is in the “up” position when the control is vertical (perpendicular to the telescope tube). To place the flip-mirror in the “down” position, turn the control until it is horizontal.

15. Front lens: The high quality 80mm Achromatic lens starts with two pieces of optical glass.

16. OTA mounting thumbscrews: Attaches the ETX optical tube to the mount using two ¼-20 mounting screws. Take off the optical tube to reduce the telescope weight or size. Install another optical tube to make the ETX observer even more versatile.

17. Bubble level/compass: Used to aide in setting the telescope in the Home Position. See page 12, Fig 4. When placed in the 90° eyepiece holder the bubble level compass can be used to level the telescope and determine the direction of magnetic North.

18. Horizontal lock knob: Controls the manual horizontal rotation of the telescope. Loosen the horizontal lock counterclockwise to unlock the telescope, enabling it to be freely rotated by hand about the horizontal axis.

Tightening the horizontal lock clockwise prevents the telescope from being rotated manually, but engages the horizontal motor drive clutch for AudioStar operation. When polar aligned, the horizontal lock serves as the Right Ascension or R.A. lock.

19. Battery compartment: Accessible thru the battery compartment door on top of base housing. Install six user-supplied AA batteries, oriented as shown on the diagram on the battery slots of the battery holder in this compartment. See page 7 for more

information. Replace the cover.

CAUTION: Use care to install batteries as indicated by the battery compartment. Follow battery manufacturer’s precautions. Do not install batteries backwards or mix new and used batteries. Do not mix battery types. If these precautions are not followed, batteries may explode, catch fire, or leak. Improperly installed batteries void your Meade warranty. Always remove the batteries if they are not to be used for a long period of time.

20. Horizontal setting circle: See page 58 for detailed information.

21. 2x Flip-Barlow: Flip the switch to engage the Barlow. The Barlow doubles the magnification (2x) of your eyepiece. If you use the Flip Barlow, you may need to turn the focus knob in a counterclockwise direction 20 or more turns to focus with the Barlow engaged. When using the Barlow, you’ll notice your viewing field of view decreases.

22. Dew Shield (not shown): Slows down the advance of dew formation on the optics, which distorts the view.

The ETX 90/125 Telescope - Key Features

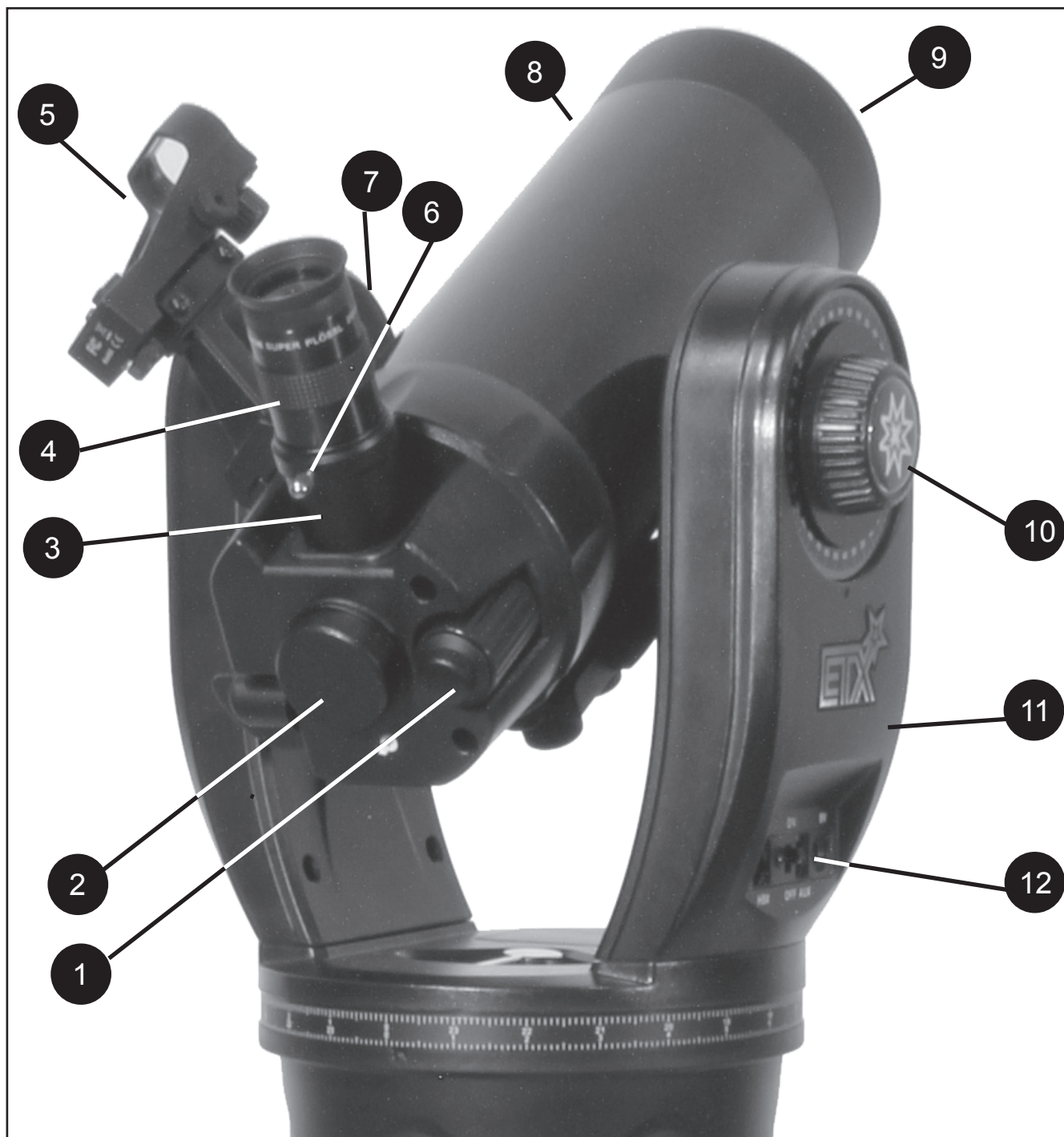

- | | |
|-------------------------------|----------------------------------|
| 1. Focus knob | 7. Red dot viewfinder thumbscrew |
| 2. Rear photo port | 8. Optical tube |
| 3. Eyepiece holder | 9. Dust cover (not visible) |
| 4. Eyepiece | 10. Vertical lock knob |
| 5. Red dot viewfinder | 11. Fork arm |
| 6. Eyepiece holder thumbscrew | 12. Computer control panel |

Figure 12: ETX 90/125 Right Side

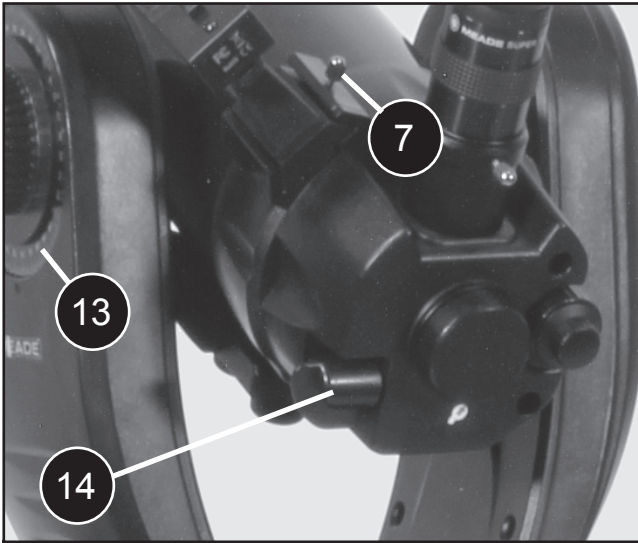

Figure 13: ETX 90/125 Left Side

- 13. Vertical setting circle knob
- 14. 90° flip mirror
- 15. Front lens
- 16. OTA mounting thumbscrews(2) (ETX 90 ONLY)
- 17. Bubble level/compass
- 18. Horizontal lock
- 19. Battery compartment
- 20. Horizontal setting circle



Figure 14: ETX 90/125 Dust Cap

- 5a. On/Off Switch
- 5b. Red dot finder adjustment knobs

- 12a. Handbox (HBX) port
- 12b. Power LED
- 12c. On/Off switch
- 12d. Auxiliary (AUX) port
- 12e. Power port (12v compatible)



Figure 16: ETX 90/125 Bubble Level

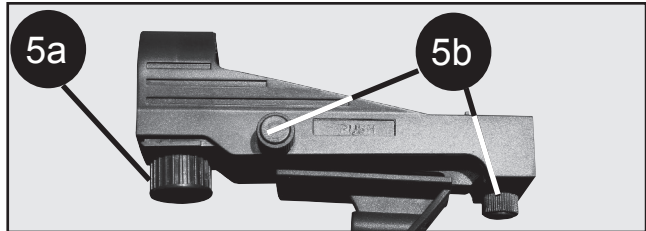

Figure 17: ETX 90/125 Red Dot

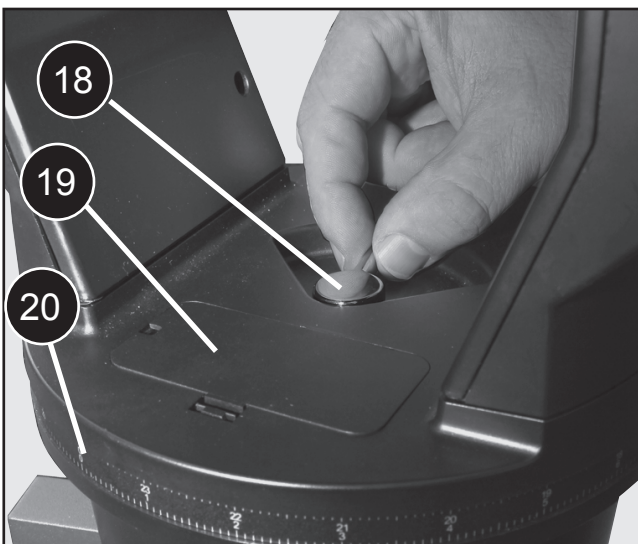

Figure 15: ETX 90/125 Top of Base

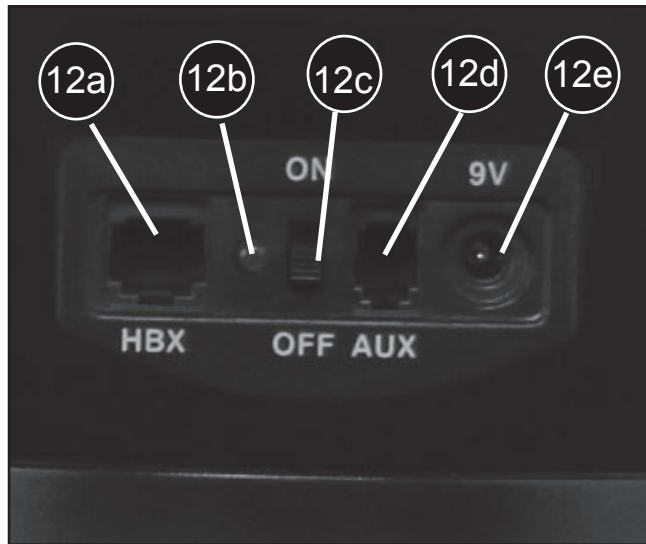

Figure 18: ETX 90 Control Panel

1. **Focus knob:** Moves the telescope's primary mirror in a finely-controlled motion to achieve precise image focus. The ETX 90 telescope can be focused on objects from a distance of about 13 ft to infinity. Rotate the focus knob clockwise to focus on distant object. Meade makes a complete line of accessories to enable you to get the most fun and performance from your ETX telescope. No matter what you want to accomplish, we have the equipment to help you get there.
2. **Rear photo port:** Attach any 35mm camera with a removable lens to this port using an optional #64 T-Adapter or attach the #932 45° Erecting Prism for correctly oriented images through the eyepiece. See OPTIONAL ACCESSORIES, page 44.
3. **Eyepiece holder:** Holds the eyepiece upright for easy viewing.
4. **Eyepiece:** Place the supplied 26mm eyepiece into the 90° Eyepiece Holder (Pg 18, Fig. 12, 3) and tighten in place with thumbscrew (Pg 18, Fig. 12, 6). Change the eyepiece to a lower focal length eyepiece and zoom in on your target.
5. **Red dot viewfinder:** Provides an easier way to locate objects than in the main telescope eyepiece which has a narrower field of view.
 - 5a. **Red dot viewfinder On/off switch:** Turn the knob located underneath the viewfinder lens to turn on/off the red dot and change the intensity of the dot. (**Note:** Be sure to turn off the red dot when not in use.)
 - 5b. **Red dot viewfinder adjustment knobs:** Use these adjustment knobs to align the red dot viewfinder to the ETX optical tube. Locate an object in the telescope eyepiece and use these adjustment knobs to move the red dot until its over the same object.
6. **Eyepiece holder thumbscrew:** Locks the eyepiece in place. Insert the eyepiece in the eyepiece holder and tighten this screw until firm.
7. **Red dot viewfinder thumbscrew:** Locks the viewfinder in place. Insert the red dot viewfinder in its mounting bracket and tighten this screw until firm.
8. **Optical tube:** The main optical component that gathers the light from distant objects and brings this light to a focus for examination with the eyepiece.
9. **Dust Cover:** Remove the dust cover counterclockwise from the front lens of the telescope before observing.
10. **Vertical lock knob:** Controls the manual vertical movement of the telescope. Turning the vertical lock counterclockwise unlocks the telescope enabling it to be freely rotated by hand about the vertical axis. Turning the vertical lock clockwise (to a firm feel only) prevents the telescope from being moved manually, but engages the vertical motor drive clutch for AudioStar operation. When polar aligned, the vertical lock serves as the Declination or Dec. lock.

Note: The vertical lock knob is a knurled knob located on the fork arm to the right of the focus knob (Pg 18, Fig. 12, 10). Mounted beneath the knob is a circular scale without numbers. Do not confuse this scale with the Dec. setting circle (Pg 19, Fig. 15, 20) on the opposite fork arm which has a numbered scale used to locate astronomical objects manually.
11. **Fork arm:** Holds the optical tube in place.
12. **Computer control panel:** (see Pg 19, Fig. 18).
 - 12a. **Handbox (HBX) port:** Plug the AudioStar handbox into this port.
 - 12b. **Power LED:** The red power indicator light illuminates when power is supplied to the telescope's motor drive.
 - 12c. **On/off switch:** Turns the Computer Control Panel and AudioStar handbox ON or OFF.
 - 12d. **Auxiliary (AUX) port:** Provides connection for current and future Meade accessories. See OPTIONAL ACCESSORIES, page 44.
 - 12e. **Power port:** Designed to accept 12 volt external power including the Meade #07584 12V AC adapter and LXPS power supply. See OPTIONAL ACCESSORIES on page 44.
13. **Vertical setting circle: (on left fork arm):** See

page 58 for detailed information.

- 14. 90 degree flip mirror:** ETX telescopes include an internal mirror. With the flip-mirror control in the “up” position light is diverted to the eyepiece. With the flip-mirror control in the “down” position light proceeds straight out the photo port for photography.

Note: The flip-mirror control is in the “up” position when the control is vertical (perpendicular to the telescope tube). To place the flip-mirror in the “down” position, turn the control until it is horizontal.

- 15. Front lens:** The high quality 90mm & 125mm optics start with a front lens made of optical glass. The primary and secondary mirrors are carefully aligned inside the optical tube to provide the best image possible.

- 16. OTA mounting thumbscrews(ETX 90 ONLY):** Attaches the ETX90 optical tube to the mount using two ¼-20 mounting screws. Take off the optical tube to reduce the telescope weight or size. Install another optical tube to make the ETX observer even more versatile. NOTE: The ETX125 OTA cannot be removed.

- 17. Bubble level/compass:** Used to aide in setting the telescope in the Home Position. See page 19. When placed in the 90° eyepiece holder the bubble level compass can be used to level the telescope and determine the direction of magnetic North.

- 18. Horizontal lock knob:** Controls the manual horizontal rotation of the telescope. Loosen the horizontal lock counterclockwise to unlock the telescope, enabling it to be freely rotated by hand about the horizontal axis.

Tightening the horizontal lock clockwise prevents the telescope from being rotated manually, but engages the horizontal motor drive clutch for AudioStar operation. When polar aligned, the horizontal lock serves as the Right Ascension or R.A. lock.

- 19. Battery compartment:** Accessible thru the battery compartment door on top of base housing. Install the user-supplied AA batteries, oriented as shown

on the diagram on the battery slots of the battery holder in this compartment. See page 7 for more information. Replace the cover.

CAUTION: Use care to install batteries as indicated by the battery compartment. Follow battery manufacturer’s precautions. Do not install batteries backwards or mix new and used batteries. Do not mix battery types. If these precautions are not followed, batteries may explode, catch fire, or leak. Improperly installed batteries void your Meade warranty. Always remove the batteries if they are not to be used for a long period of time.

- 20. Horizontal setting circle:** See page 58 for detailed information.

The AudioStar Handbox

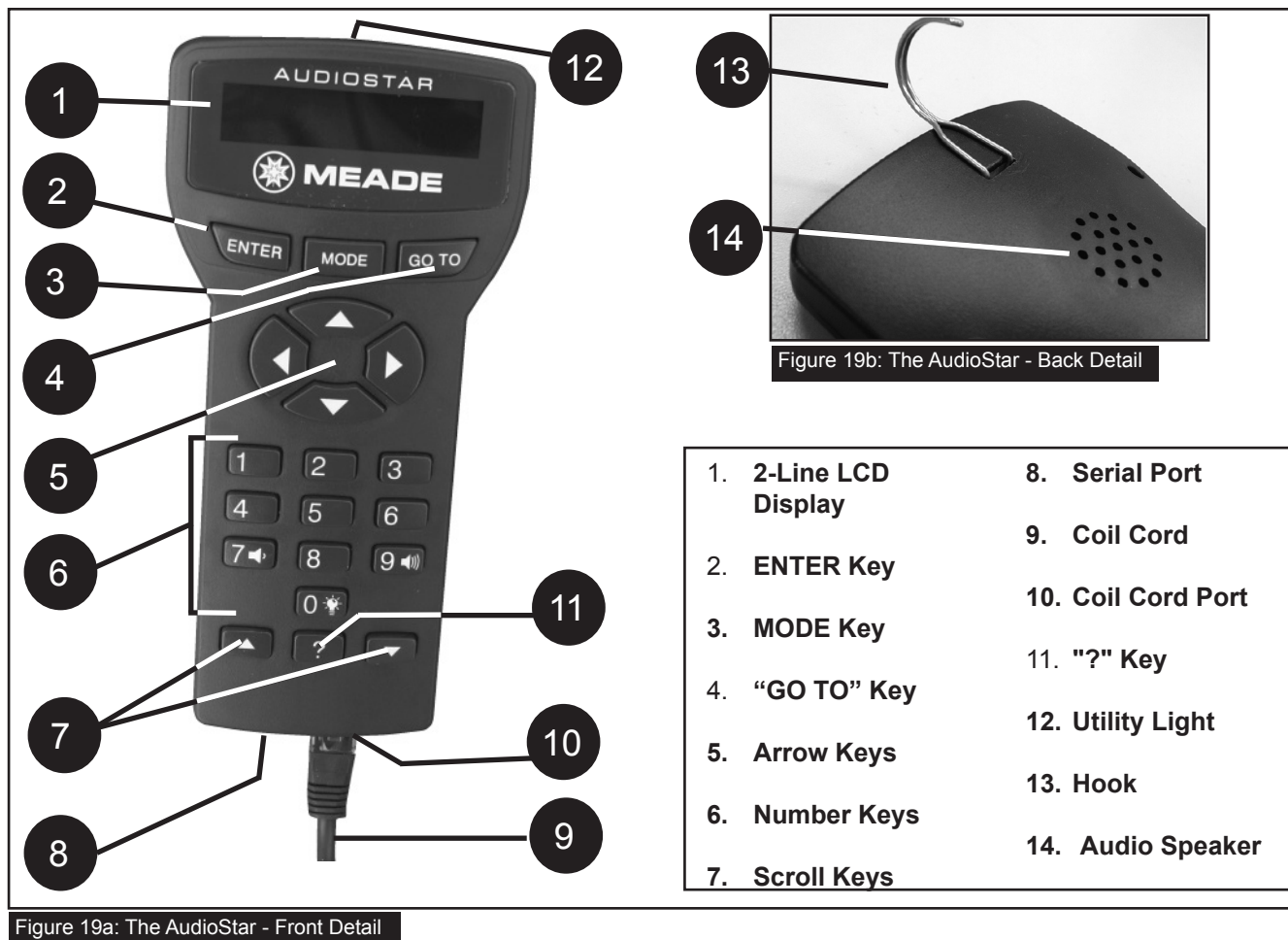

Tour the Cosmos with Just the Push of a Button

Control of the ETX Observer is through the operation of the standard-equipment AudioStar. Nearly all functions of the telescope are accomplished with just a few pushes of AudioStar's buttons. Some of the major features of AudioStar are:

- Automatically move the telescope to any of over 30,000 objects stored in the database or manually enter the astronomical coordinates of any celestial object.
- Take a guided tour of the best celestial objects to view on any given night of the year.
- Meade's Astronomer Inside audio content. Listen through its built-in speaker as it tells you fun and informative descriptions of over 500

night sky objects as you actually view them in the eyepiece.

- Download the latest software revisions directly from the Meade website (www.meade.com) and share software with other AudioStar enthusiasts.
- Control your ETX with your PC using a serial interface.
- Access a glossary of astronomical terms.
- Calculate which eyepiece to use for optimum viewing of a celestial object.
- Mount the telescope in the "Alt/Az" mode (Altitude - Azimuth, or vertical - horizontal) for fully automatic tracking of celestial objects.

The AudioStar Computer Controller provides control of virtually every telescope function within a compact handbox. AudioStar has soft-touch keys designed to have a positive feel. The LCD (Liquid Crystal Display) is back-lit with a red LED (Light Emitting Diode) for easy viewing in the dark. The back-lit display, key arrangement, and sequential database make AudioStar extremely user friendly.

1 2-Line LCD Display: Provides an interface between AudioStar and the telescope.

- **Top line:** Lists the primary category or menu item.
- **Bottom line:** Contains a menu option or information about an object or subject, depending on which function is being performed.

2 ENTER Key: Accesses, in a sequential manner, the next menu or data level in the AudioStar database. See MOVING THROUGH AudioStar's MENUS, page 10.

NOTE: If ENTER is pressed for two seconds or more and then released, AudioStar emits a beep and "ENTER to Sync" is displayed. "ENTER to Sync" is relevant only after the telescope has been aligned and is pointing at an object. If the "ENTER to Sync" feature is accessed by mistake, press MODE to return to the previous screen. See High Precision, page 32, for more details about this feature.

3 MODE Key: Returns to the previous menu or data level in the AudioStar database until the top level, "Select Item" is reached. The MODE key is similar to the back key on a smart phone.

Note: Pressing MODE while in the "Select Item" level moves AudioStar to the topmost screen: "Select Item: Object".

If MODE is pressed and held for two seconds or more, information about the telescope's status displays. When the status displays, press one of the Scroll keys (Pg. 22, Fig. 19a, 7) to display the following information:

- Right Ascension and Declination (astronomical) coordinates
- Altitude (vertical) and Azimuth (horizontal) coordinates
- Date

- Site coordinates
- Local Time and Local Sidereal Time (LST)
- Timer and Alarm Status
- Battery status

Press MODE again to return to the previous menu.

4 GO TO Key: Slews (moves) the telescope to the coordinates of the currently selected object. While the telescope is slewing, the operation may be aborted at any time by pressing any key except GO TO. Pressing GO TO again resumes the slew to the object.

5 Arrow Keys: Slew the telescope in a specific direction (up, down, left, and right), at any one of nine different speeds. Speed selection is explained in "SLEW SPEEDS", below. The following functions are also available with the Arrow keys:

- Moves the telescope – Use the Up and Down Arrow keys to move the telescope vertically up and down. The Left Arrow key rotates the telescope horizontally counterclockwise, while the Right Arrow key rotates it clockwise.
- Data entry – When the scope is prompting for user entered data, use the Up and Down Arrow keys to scroll through the letters of the alphabet and numerical digits. The Down Arrow key starts with the letter "A" and the Up Arrow key starts with the digit "9." The Left and Right Arrow keys are used to move the blinking cursor left and right across the LCD display.

6 Number Keys: Input digits 0 - 9 and changes the slew speeds (see Slew Speeds, see below). The "0" key also turns on and off the red utility light on the top of the handbox.

Slew Speeds

ETX has nine slew speeds that are directly proportional to the sidereal rate (the rate at which stars appear to drift across the sky) and have been calculated to accomplish specific functions. Pressing a Number key changes the slew speed, which is shown for about two seconds on AudioStar's display.

To change the speed, press the appropriate key shown below.

Nine available speeds are:

Number Key "1" = 1x (Guide)

Number Key "2" = 2x

Number Key "3" = 8x

Number Key "4" = 16x

Number Key "5" = 64x

Number Key "6" = 0.50°/sec

Number Key "7" = 1.0°/sec

Number Key "8" = 1.5°/sec

Number Key "9" = 4.0°/sec (Max)

Speeds "1", "2", or "3": Best used for fine centering of an object in the field of view of a higher power eyepiece, such as a 12mm or a 9mm eyepiece.

Speeds "4", "5", or "6": Enables centering an object in the field of a low-to-moderate power eyepiece, such as the standard Super Plössl 26mm.

Speeds "7" or "8": Best used for rough centering of an object in the Red Dot Viewfinder.

Speed "9": Moves the telescope quickly from one point in the sky to another.

- 7 Scroll Keys:** Accesses options within a selected menu. The menu is displayed on the first line of the screen. Options within the menu are displayed, one at a time, on the second line. Press the Scroll keys to move through the options. Press and hold a Scroll key to move quickly through the options.

The Scroll keys also scroll through the letters of the alphabet and numerical digits.

Note: The Scroll Down key and the Down Arrow key move forward through the alphabet & digits (A to Z, 0 to 9). The Scroll Up key and the Up Arrow key move backward (Z to A, 9 to 0). Common symbols are also available in the list.

- 8 Serial Port:** Plug a serial accessory (#505) cable into AudioStar for updating functions such as "Download" or "Clone". See page 33 for more details.
- 9 Coil Cord:** Plug one end of the AudioStar coil cord into the HBX port (Pg. 15, Fig. 11, 12a) of the computer control panel of the telescope and

the other end into the coil cord port.

- 10 Coil Cord Port:** Plug one end of the AudioStar coil cord into this port (pg. 22, Fig. 19a, 10) located at the bottom of the AudioStar handbox.
- 11 ? Key:** Accesses the "Help" file. "Help" provides on-screen information on how to accomplish whatever task is currently active.

Hold down the ? key and then follow the prompts on the display to access details of AudioStar functions in the Help feature. The Help system is essentially an on-screen instruction manual.

If you have a question about an AudioStar operation, e.g., INITIALIZATION, ALIGNMENT, etc., hold down the ? key and follow the directions that scroll on the second line of the LCD screen. When a word appears in [brackets], press ENTER to access the AudioStar Glossary. A definition or more detailed information is displayed. Press MODE to return to the scrolling AudioStar Help display.

When satisfied with the Help provided, press MODE to return to the original screen and continue with the chosen procedure.

- 12 Utility Light:** Use this built-in red light to illuminate star charts and accessories without disturbing your eye's adaptation to darkness.
- 13 Hook:** Attach the metal hook to the back side of AudioStar. Allows the AudioStar to be hung on various places on the ETX for quick access.
- 14 Audio Speaker:** Built-in speaker plays Astronomer Inside audio content.

Observing Using AudioStar's Arrow Keys

You may observe land and astronomical objects using AudioStar's Arrow keys to move the telescope.

1. Verify the telescope is fully assembled and that AudioStar is properly connected to your telescope. See Getting Started on page 5.
2. Flip the telescope power switch to the ON position. The AudioStar screen is activated and a copyright message displays briefly, followed by a short beep. Then AudioStar takes a few

moments to start up the system. “Press 0 to align or Mode for Menu” displays (if you select “0”, Alignment will begin).

3. The Arrow keys are now activated. Press the Arrow keys (Pg. 22, Fig. 19a, 5) to slew (move) the telescope up, down, right, or left.
4. Press a Number key (Pg. 22, Fig. 19a, 6) to change the telescope’s slew speed. See Slew Speeds, on pg 24 for more information.
5. Use the viewfinder (Pg. 15, Fig 10, 5) to locate an object and practice using the AudioStar’s Arrow keys to center the object in the telescope’s field of view.
6. Use the telescope’s focus knob (Pg. 14, Fig. 5, 1 or Pg. 18, Fig 12, 1) to bring the object into focus.

Observe the Moon

Point your telescope at the Moon (note that the Moon is not visible every night) and practice using the Arrow keys and the slew speeds to view different features. The Moon contains many interesting features, including craters, mountain ranges, and fault lines.

The best time to view the Moon is during its crescent or half phase. Sunlight strikes the Moon at an angle during these periods and adds a depth to the view. No shadows are seen during a full Moon, causing the overly bright surface to appear flat and rather uninteresting. Consider the use of a neutral density Moon filter when observing the Moon. Not only does it cut down the Moon’s bright glare, but it also enhances contrast, providing a more dramatic image.

Terrestrial Observing

The ETX is an excellent high-resolution, terrestrial (land) telescope. Viewing terrestrial objects requires looking along the Earth’s surface through heat waves. These heat waves often cause degradation of image quality. Lower power eyepieces, like the Super Plössl 26mm eyepiece, magnify these heat waves less than higher power eyepieces. Therefore, lower power eyepieces provide a steadier, higher quality image.

If the image is fuzzy or ill-defined, reduce to a lower power eyepiece, where the heat waves do not have

such an effect on image quality. Observing in early morning hours, before the ground has built up internal heat, produces better viewing conditions than during late afternoon hours.

If you wish to observe a distant land object, such as a mountain top or a bird, you want to use your telescope in its Terrestrial Observing mode. To start up the telescope in Terrestrial mode:

1. Turn on the telescope.
2. Move your telescope using the direction arrows on the handbox while looking through the Red-Dot Finder to put your target in the eyepiece.
3. Focus on the target with the focus knob (Pg. 14, Fig. 5, 1 or Pg. 18, Fig 12, 1).

ETX OBSERVER TIPS

Observing Considerations

- Try to pick an observing site away from street and house lights and car headlights. While this is not always possible, the darker the site, the better.
- Try not to use a standard flashlight. Experienced observers use red LED flashlights, the red utility light on the AudioStar handbox, or tape red cellophane over their flashlights to use for setup and map reading so they don’t have to continually readjust their eyes to the darkness. Be careful not to shine bright lights if there are other observers in the area. Do not shine a flashlight into the telescope while someone is observing!
- Dress warmly. It gets chilly when you’re sitting for prolonged periods.
- Practice setting up your equipment during the day or in a lighted area to become familiar with it before going to a dark site.
- Use your 26mm eyepiece to view terrestrial objects and wider areas of space, such as open star clusters. Use optional higher power eyepieces, such as a 9mm eyepiece, when you wish to view something up close, such as craters on the Moon or the rings of Saturn.

AudioStar Operation

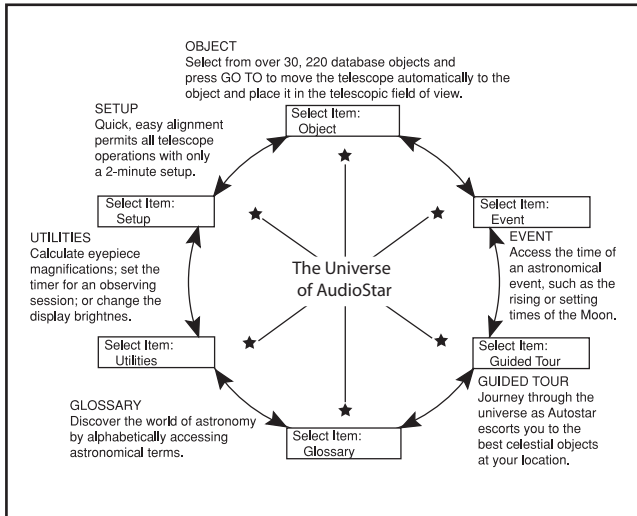

Fig. 20: The AudioStar Universe: The six primary categories listed in the Select Item menu of AudioStar.

It is important to understand that menu selections are set in a loop (Fig. 21). This means that pressing the Scroll Down key (Pg. 22, Fig. 19a, 7) cycles down through all the available options within a given category, then returns to the first option. The Scroll Up key (Pg. 22, Fig. 19a, 7) cycles up through the options in the opposite order. Note that this capability is a quick way to get to an option that is near the bottom of the list. The following example demonstrates this capability.

Example:

To navigate to the “Select Item: Setup” menu option when the “Select Item: Object” menu is displayed:

1. Press the Scroll Down key four times or the Scroll Up key once.

The screen in Fig. 19a displays two lines of information. The top line shows the current menu level. The second line displays an option which may be selected within that menu level. Some options are choices that select the next menu level down. The Scroll keys move up and down within the list of available options, showing one option at a time.

When the desired option is displayed on the second line, press the ENTER key to choose that option and

move down one menu level.

Press the MODE key to leave a level; e.g., the wrong menu option is chosen.

Important Note: No matter how many levels into AudioStar are traveled, each press of the MODE key moves up a level, until the top level, “Select Item”, is reached. Once in the Select Item level, press MODE to return to the topmost level, “Select Item: Object”.

AudioStar Navigation Exercise

To demonstrate how the AudioStar menu structure works, the following exercise calculates Sunset time so an evening observing session can be planned.

To Calculate Sunset time:

1. Press the MODE key several times, until “Select Item: Object” is displayed.
2. Press the Scroll Down key once to display the “Event” option in the “Select Item” menu.
3. Press the ENTER key to choose the “Event” option and move down a level. “Event: Sunrise” is displayed.
4. Press the Scroll Down key once to display the “Sunset” option in the Event menu.
5. Press the ENTER key to choose the “Sunset” option and move down another level.
6. AudioStar calculates the Sunset time based on the current date, time, and location. AudioStar then displays the results of the calculation.
7. Press MODE once to start moving back up through the AudioStar levels. The first level up

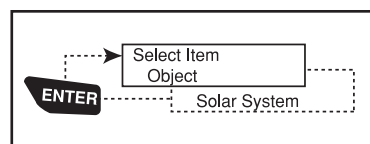

Figure 21a: AudioStar Levels

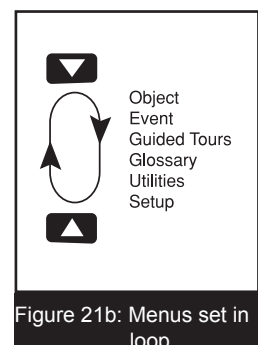

Figure 21b: Menu set in loop

is the Event menu.

8. Press MODE again to move up another level. This is the top level, "Select Item".
9. Press MODE again to return to the starting point of "Select Item: Object".

Entering Data into AudioStar

- To enter numbers and text:
 - A) Use the Number keys, or
 - B) Use the Arrow keys to scroll through numbers 0 - 9 and the alphabet. The Down Arrow key begins with the letter "A"; the Up Arrow key begins with digit "9".
- To move the cursor across the display: Use the Right or Left Arrow key (Pg. 22, Fig. 19a, 5) to move the cursor from one number to the next in the display
- Press ENTER when the desired information has been entered.

Navigating AudioStar

AudioStar's menus are organized for quick and easy navigation:

- Press ENTER to go deeper into AudioStar's menu levels.
- Press MODE (Pg. 22, Fig. 19a, 3) to move back toward the top menu level.
- Press the Scroll keys to move up and down through the options or lists.
- Press the Arrow keys to move the cursor across the display.
- Press the Help (?) key to access on-line help.

When multiple choices are available within a menu option, the option that is currently selected is usually displayed first and highlighted by a right pointing arrow (>).

Guided Tour Menu

When Guided Tours is selected, ETX shows you a list of theme tours that will help you explore the night

sky. These tours are pre-programmed presentations of objects that are visible for the user's particular location, time and date.

The most popular tour is "Tonight's Best" that guides the user to the best objects that are currently up in the night sky. This tour is the easiest way to get started exploring the cosmos with your new ETX telescope.

Each tour will select the objects, present information about the object and, if you press "GoTo", put that object in the eyepiece of the telescope for you to view.

The telescope comes pre-loaded with:

- "Tonight's Best", a selection of the most interesting objects visible on any night.
- "A Star's Life", tours how stars are formed, created, changes through their lives and finally die using examples that are visible tonight.
- "How Far is Far", tour showing the phenomenal distances you can see with your ETX.

AutoStar Suite Software also allows you to create your own guided tours of the skies, including your own objects and titles (for complete instructions on how to use the authoring tools please refer to the reference manual included on the AutoStar Suite DVD).

Object Menu

Almost all observing with ETX is performed using the Object menu category. (NOTE: Exceptions include Guided Tour and Landmarks).

Many ETX menu categories contain databases. An ETX database is a list of objects, such as stars, planets, comets, nebulae and so forth. When one of these objects is selected from a database by pressing "ENTER" and then "GO TO", ETX moves your telescope (when properly aligned) and points it at the selected object.

AudioStar MENU TREE

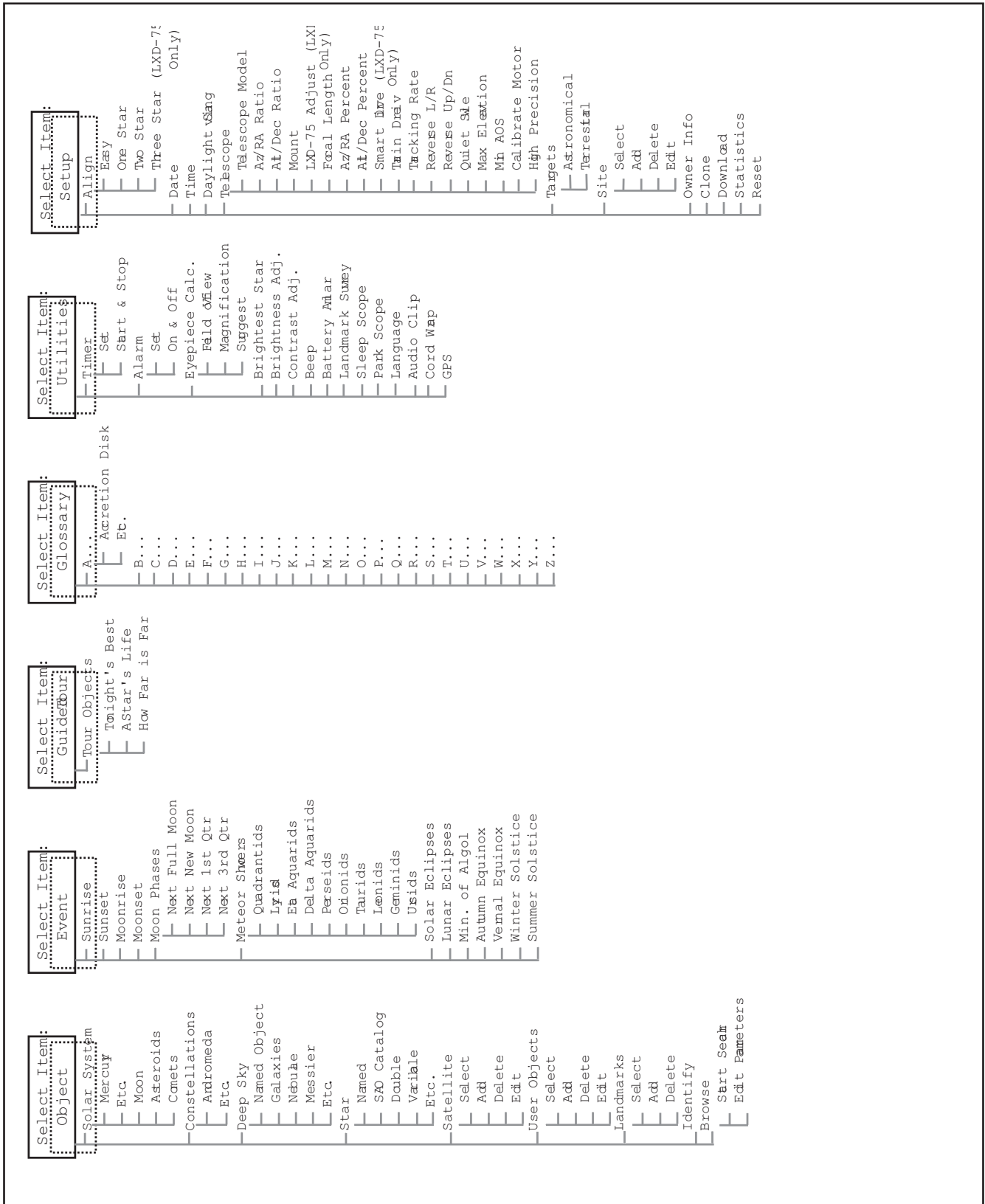

Figure 22: The AudioStar Menu Tree

The Object Menu options include:

- **Solar System** is a database of the eight planets (Earth is not included) in ascending orbits from the Sun, followed by the Moon, asteroids, and comets.
- **Constellation** is a database of all 88 Northern and Southern Hemisphere constellations. When this menu option is chosen and a constellation name appears on the first line of the screen, press GO TO once to change the second line to the name of the brightest star in the constellation.

Press GO TO a second time to slew the telescope to that star. Use the Scroll keys to cycle through the list of stars in the constellation, from brightest to dimmest.

- **Deep Sky** is a database of objects outside our Solar System such as nebulae, star clusters, galaxies, and quasars grouped in various catalogs like Messier, Caldwell and NGC.
- **Star** is a database of stars listed in different categories such as named, double, variable, or nearby.

IMPORTANT NOTE: When an object is selected, pressing “ENTER” for two seconds will synchronize the telescope’s coordinates with the object. This is most useful when syncing on bright stars to achieve better pointing in the vicinity of the star.

- **User Objects** allows the user to define and store in memory deep-sky objects of specific interest that are not currently in the ETX database. See page 29 for more information (for complete instructions on how to use the authoring tools please refer to the reference manual included on the AudioStar Suite DVD).
- **Satellite** is a database of Earth-orbiting objects such as the International Space Station (ISS), the Hubble Space Telescope Pg18e (HST), Global Positioning System (GPS) satellites, and geosynchronous orbit satellites. In order to find and track satellites, you must download recent orbital data into the telescope.
- **Landmarks** stores the location of terrestrial points of interest that you create in the permanent ETX 90 database.

IMPORTANT NOTE: To use the Landmark function, the telescope must be located and aligned exactly as when the landmark was added to the database.

- **Select** – To select a Landmark already in the database (see ADD below), choose the “Select” option and scroll through the list. Press “ENTER” to select a Landmark, then press “GOTO” and the telescope slews to the object.

Add – To add a Landmark, choose the “Add” option. Enter a name for the Landmark. Locate and center the Landmark in the eyepiece, then press “ENTER”.

- **Identify** is an exciting feature for an observer who wants to scan the night sky and start exploring. After the telescope has been properly aligned, use the AudioStar Arrow keys to move about in the sky. Then follow this procedure:

Important Note: Only use the Arrow keys to move the telescope during the Identify procedure. Do not move the telescope manually or the alignment will be lost.

1. When a desired object is visible in the eyepiece, keep pressing MODE until the “Select Item: Object” menu is displayed. Press ENTER to select this menu.
 2. Scroll through the Object menu options until the “Object: Identify” screen appears.
 3. Press ENTER. AudioStar searches the database for the identity of the object being observed.
 4. If the telescope is not directly on an AudioStar database object, the nearest database object is located and displayed on the screen. Press GO TO and the telescope slews to that object.
- **Browse** allows you to search the database for objects with certain parameters, much like a search engine. “Edit Parameters” lets you set various parameters for the search, such as: Object Type, Minimum Elevation, Largest, etc. Once you have set the parameters of the search, select “Start Search” and press ENTER. AudioStar will display the results of the search. See page 29 for more information.

-

Event Menu

The Event menu provides access to dates and times of astronomical events. The Event database includes:

Sunrise and Sunset calculates the time that the Sun rises or sets on the current date.

Moon rise and Moon set calculates the time that the Moon rises or sets on the current date.

Moon Phases displays the date and time of the next New, 1st Quarter, Full and 3rd Quarter Moon.

Meteor Showers provides information on upcoming meteor showers, such as the Perseids, the Leonids, etc. Also lists the dates of the showers and when they reach maximum.

NOTE: Meteors are fast moving objects that cover large areas of the sky and are usually best observed with the naked eye.

Solar Eclipse lists upcoming Solar Eclipses, including the date and type (total, annular, or partial) of eclipse, and the location and time of the first and last contacts of the Moon's shadow. Use the Scroll Up and Down keys to display the available data. **Remember, never use a telescope to look at the Sun!**

Lunar Eclipse lists upcoming Lunar Eclipses, including the date and type (total, partial, penumbral) of eclipse. Use the Scroll Up and Down keys to display the available data.

Min. (Minimum) of Algol is the minimum brightness of the dramatic eclipsing binary star system, Algol. It is relatively close at a distance of 100 light years. Every 2.8 days during a 10 hour period, Algol undergoes a major change in apparent magnitude as one of the two stars passes behind the other. The combined magnitude of the two stars thus dips from +2.1 to a minimum of +3.4 halfway through the eclipse as the second star is hidden. ETX calculates minimum magnitude time at mid-eclipse.

Autumn and Vernal Equinox calculates the time and date of the fall or spring equinox of the current year.

Winter and Summer Solstice calculates the time and date of the winter or summer solstice of the current year.

Glossary Menu

The Glossary menu provides an alphabetical listing of definitions and descriptions for common astronomical

terms and AudioStar functions. Access directly through the Glossary menu or through hypertext words embedded in AudioStar. A hypertext word is any word in [brackets], usually found when using the AudioStar Help function or when reading a scrolling message such as a description of a planet or star. Press ENTER whenever a hypertext word is on screen and AudioStar goes to the glossary entry for that word.

To access directly from the Glossary menu, use the Scroll keys to scroll through the alphabet. Press ENTER on the desired letter. Scroll to the desired entry and then press ENTER to read the description.

Utilities Menu

The Utilities menu provides access to several extra features within AudioStar, including a countdown timer and an alarm. The Utilities functions include:

Timer selects a countdown timer. This feature is useful for functions such as astrophotography and tracking satellites. See OBSERVING Satellites, page 36. To use the Timer, press ENTER, then choose "Set" or "Start/Stop."

- **Set:** Enter the time to be counted down, in hours, minutes, and seconds, then press ENTER.
- **Start/Stop:** Activates the timer set previously. Use the Scroll keys to toggle between ON and OFF. When ON is displayed, press ENTER to activate the timer. When the timer runs out, four beeps sound and the timer is deactivated

Alarm: selects a time for an alarm signal as a reminder. To use the Alarm, press ENTER, then choose "Set" or "Start/Stop".

- **Set:** Enter the time of day for the alarm to sound, in hours, minutes, and seconds, then press ENTER.
- **Start/Stop:** Activates the alarm set previously. Use the Scroll keys to toggle between ON and OFF. When ON is displayed, press ENTER to activate the alarm. When the alarm time arrives, AudioStar beeps. Press ENTER to deactivate the alarm.

Eye-piece Calc: calculates information about an eye-piece for the specific telescope to which AudioStar is

connected.

Field of View: Scroll through a list of available eyepieces. When an eyepiece is selected, the field of view is calculated.

- **Magnification:** Scroll through a list of available eyepieces. When an eyepiece is selected, the magnification is calculated.
- **Suggest:** AudioStar calculates and suggests the best eyepiece for viewing, based on the telescope and the object being viewed.
- **Suggest:** Brightness Adj adjusts the brightness of the display using the Scroll keys. When complete, press ENTER.

Contrast Adj adjusts the contrast of the display using the Scroll keys. When complete, press ENTER.

Note: This feature is usually only required in very cold weather.

Landmark Survey automatically slews the telescope to all user-defined landmarks with a short pause at each location. Press ENTER to start the survey. While a slew is in progress, press any key to skip that object and go to the next landmark on the list. To observe a landmark for a longer period, press MODE when paused on the object to stop the survey. Press ENTER to restart the survey at the first object on the list. See Landmarks, page 40.

Sleep Scope is a power saving option that shuts down AudioStar and the telescope without forgetting its alignment. With “Sleep Scope” selected, press ENTER to activate the Sleep function. AudioStar goes dark, but the internal clock keeps running. Press any key, except ENTER, to re-activate AudioStar and the telescope.

Park Scope is designed for a telescope that is not moved between observing sessions. Align the telescope one time, then use this function to park the telescope. Next time it is powered up, enter the correct date and time – no alignment is required. Pressing ENTER causes the telescope to move to its pre-determined Park position. Once parked, the screen prompts to turn off power.

Important Note: When the “Park Scope” option is chosen and the display prompts you to turn off the telescope’s power, AudioStar is unable to be returned to operation without turning the power off and then back on.

Cord Wrap, when set to “On”, moves the telescope in such a way as to prevent the cords and cables attached to your telescope assembly from getting wound around the assembly and tangled as the telescope slews to objects. “Off” is the default setting.

Setup Menu

The Setup menu’s primary function is to align the telescope. However, there are numerous other features available within the Setup menu, including:

Date changes the date used by AudioStar. This function is useful to check events in the past or future. For example, set the Date menu for a day three months in the future. Then check the “Select Item: Event” menu for the Sunset time on that date. See EVENT MENU, page 29.

Time changes the time entered into AudioStar. Setting the correct time is critical for AudioStar to properly calculate locations and events. Time may be set to 24-hour mode (military time) by selecting the “blank” option which follows the “AM” and “PM” options.

Daylight Saving is used to enable or disable Daylight Savings time.

Note: Daylight Savings Time may be referred to by different names in various areas of the world. Check local time to verify.

Telescope accesses the several options, including:

- **Model:** Allows you to select the telescope model connected to AudioStar.
- **Focal Length:** Displays the focal length of the selected telescope.
- **Az Ratio and Alt Ratio:** The Az (Azimuth) ratio and Alt (Altitude) ratio refers to the gears of the telescope’s motors. Do not alter these numbers.
- **Az Percent:** The Az (Azimuth) Percent allows you to change the azimuth backlash, i.e., the way the Arrow keys move the telescope along the azimuth (horizontal) axis. If you enter a value near 100, the telescope tube responds more quickly (it responds immediately at 100%) as you hold down an Arrow key and also slews (moves) the tube more quickly. If you enter

a value near 0, it takes longer for the tube to respond as you hold down an Arrow key and also slews the tube more slowly. Experiment with this option. Try changing the percent value until you get a “feel” for the Arrow keys that is comfortable for you.

- **Alt Percent:** The Alt (Altitude) Percent operates identical to the Az Percent option (see above), but allows you to change the altitude backlash, i.e., the way the Arrow keys move the telescope when moving along the altitude (vertical) axis.

- **Train Drive:** Trains the Altitude and Azimuth motors to locate objects with more precision.

If you are experiencing any problems with pointing accuracy, follow the procedure described in APPENDIX A: TRAINING THE DRIVE, page 50, to insure accurate pointing and tracking.

- **Tracking Rate:** Changes the speed at which the telescope tracks targets in the sky.

A. Sidereal: The default setting for AudioStar; sidereal rate is the standard rate at which stars move from East to West across the sky due to the rotation of the Earth.

B. Lunar: Choose this option to properly track the Moon over long observing sessions.

C. Custom: Allows entry of user-defined tracking rates.

- **Reverse L/R** reverses the functions of the Left and Right Arrow keys (i.e., the Right key moves the telescope to the left).
- **Reverse UP/DOWN** reverses the functions of the Up and Down Arrow keys (i.e., the Up key moves the telescope down).
- **Quiet Slew** sets the maximum slew rate to 1.5° for quieter operation.
- **Max Elevation** allows you to enter a value in degrees that sets a limit as to how far the optical tube can swing upward during a programmed slew. (Note that it does not prevent you from performing a manual slew past this limit.) This is useful when you have a camera or other peripheral attached to the telescope—you can prevent it from striking the telescope base.

- **Min AOS** (Acquisition of Signal) allows you to enter a value in degrees. This value represents the altitude at which your telescope begins to slew when acquiring a satellite track. This is useful when you are observing satellites, but a tall tree or building is obstructing the telescope. For example, you might begin to track the satellite at 15° altitude, instead of 5°. See Observing Satellites, page 36, for more information about satellites.

- **Calibrate Motor** if the telescope motors appear to have a problem, use this option to retest the motors before performing a Reset. This option is also used if an AudioStar unit is moved between telescopes, to match AudioStar to the new telescope. To calibrate the motors, select this option and press ENTER.

- **High Precision** if turned on, when looking for a faint celestial object (i.e., a nebula or galaxy), AudioStar first slews to a nearby bright star and displays “Center (Star name) Press Enter”. Center the star in the eyepiece, then press ENTER. At that point the telescope has a high precision alignment to that part of the sky and it then slews to the object that was originally requested.

Targets switches between Astronomical targets and Terrestrial targets. If “**Astronomical**” is selected, the telescope tracking motor is activated and any object you observe will remain centered in the eyepiece. If “**Terrestrial**” is selected, the tracking motor is turned off.

Site provides access to several options including:

- **Select:** Displays36 the currently selected observing site. Use the Scroll keys to cycle through all available sites (see Add below). Press ENTER when the site you wish to select displays. Use this option when you move to a different geographic location.
- **Add:** Allows you to add new observing sites to the database (up to six sites may be stored). Scroll through the list of Countries/States. Press ENTER when the site you wish to add displays. Then choose the desired city in the same manner.

- **Delete:** Deletes a stored site from the database.
- **Edit:** Edits a selected site, including: the name, latitude, longitude, and time zone. Time Zone refers to the Greenwich Mean Time (GMT) time zone shift. Users West of Greenwich, England use “-” hours, East of Greenwich use “+” hours. For the United States, look up the time zone shift in the table at left.

AudioStar compensates for daylight savings time, if selected. See Setup Menu: Daylight Saving, page 31.

Owner Info accesses the owner information menu, including:

- **Name:** Users may enter both their first and last names using the Up and Down Arrow keys to cycle through the alphabet. Use the Right and Left Arrow keys to move through the text. Press ENTER when the entry is complete.
- **Address:** Use the Up and Down Arrow keys to enter your street address, city, state, and zip code. Press ENTER when the entry is complete.

Download transfers information from another AudioStar during cloning (see below). During the operation, the warning “Downloading Do Not Turn Off” appears.

Note: The Download function requires the optional #505 Astrofinder Software and Cable Connector Kit. See the instruction sheet included with the kit for more information on how to download. Also see OPTIONAL ACCESSORIES, page 44.

Clone uploads information from one AudioStar handbox to another. Three options are available:

- **Catalogs:** Sends only user-defined object information, such as new satellite orbits or comet data to another AudioStar handbox.
- **Software:** Sends only the basic AudioStar software. This is useful if one user has downloaded a new version of AudioStar software from the Meade website (www.meade.com) and wants to pass this software along to friends.
- **All:** Everything – user-defined information

and AudioStar software – is sent to another AudioStar.

Statistics provides basic statistical data about AudioStar, including:

- **Characters Free:** Shows how much room is available in user-defined object memory.
- **Version:** Shows the current version of the AudioStar software.

Reset completely resets AudioStar. Most values entered into the menus revert to factory defaults.

Advanced AudioStar Features

Adding Observing Sites

If you plan to observe using AudioStar at different geographic locations, you can store up to six observation sites in AudioStar's memory to help simplify your telescope setup. Perform these procedures using the Site options (Add, Select, Delete, Edit) of the Setup menu.

To Add a Site to the user-defined site list:

In this example, you will choose a city and add it to the database list. You will then select the site to enable it.

1. Navigate to the "Setup: Site" menu. Press ENTER,
2. Scroll through the options until "Site: Add" displays. Press ENTER.
3. You are given a choice to enter a zip code (press "1") or select a city from the list (press "2"). If you choose "Zip", enter the digits of your zip code and press ENTER.
4. If you choose "City", scroll through the list of countries/states. Press ENTER when the country/state you wish to add displays.
5. Scroll through the list of cities. Press ENTER when the city you wish to select displays. The sites you choose will appear at the top of the Select list (all other available sites will be listed after the sites you have chosen).
6. To choose a site, navigate to "Site: Select". Press ENTER. Scroll through the list of sites. Both Zip Codes and Cities are displayed. When the desired zip code or site displays, press ENTER.

To Edit a Site:

In this procedure, you will enter a location that is not available in the AudioStar database by editing data of a nearby site. You will edit the location's name, latitude, longitude and the time zone shift. You will then select the site to enable it.

You will need to know the latitude and longitude of your location to perform this procedure. This information is available on most maps.

1. Using the Add option, choose a site on the list that is closest to your observing site and press ENTER so that the site is added to your observing sites list. Choosing a site already on the list (as opposed to using the "Custom" feature) makes it easier to edit, as the "Time Zone" value may not need to be changed.
2. Scroll to "Site: Edit" and press ENTER. "Edit: Name" displays. Press ENTER.
3. The name of the site you have just entered to your list displays; if it does not, scroll to the site.
4. Using the Arrow keys, change the name of the site so that it now reads the name of your observing location. Press Enter. "Edit: Name" displays again.
5. Press the Scroll Down key and "Edit: Latitude" displays. Press ENTER.
6. Using the Number Keys, enter the latitude of your observing site and then press ENTER. "Edit: Latitude" displays again.
7. Press the Scroll Down key and "Edit: Longitude" displays. Press ENTER.

Time Zone	Shift
Atlantic	-4 Hours
Eastern	-5 Hours
Central	-6 Hours
Mountain	-7 Hours
Pacific	-8 Hours
Alaska	-9 Hours
Hawaii	-10 Hours

8. Using the Number Keys, enter the longitude of your observing site and then press ENTER. "Edit: Longitude" displays again.

9. Press the Scroll Down key and "Edit: Time Zone" displays. Press ENTER. (If the site you chose from the

list in step 1 has the same Time Zone as the site you are editing, just press ENTER again to go on to the next step.) "Time Zone" refers to the Greenwich Time Zone shift. Users West of Greenwich, use "-" hours (one hour per time zone) and users East of Greenwich use "+" hours. For the United States, look up the shift in Table 1, at the left.

10. After entering the shift, press ENTER. "Edit Time Zone" displays.

11. Press MODE. "Site: Edit" displays.
12. Using the Arrow keys, scroll to "Site: Select". The site you have just edited displays. Press ENTER to select the site or press MODE to exit.

Using AudioStar to Find Objects Not in the Database

In this procedure, you will enter coordinates of celestial objects that do not appear in any of the AudioStar database lists. You will enter the object's name and R.A. and Dec. coordinates (required information). You may also enter the object's magnitude and size (optional information).

Although AudioStar contains an extensive database of celestial objects (stars, nebulae, planets, etc.) that you can observe, you may eventually want to view objects that are not part of the database. AudioStar provides a feature that allows you to enter an object's R.A. and Dec. coordinates in the "User: Objects" option of the Object menu and allows automatic slewing of the telescope to the user-entered coordinates.

In order to use this menu option, you first need to look up the R.A. and Dec. coordinates of the object or objects you wish to observe. Check out your local library, computer store, or bookstore for astronomy books, CD ROMs, or magazines (such as Sky & Telescope or Astronomy), to find coordinates of celestial objects. The objects/coordinates you enter become part of your own permanent database, called "User Objects".

To enter coordinates of an object into the "User: Objects" option of the Object menu:

1. Make sure AudioStar has been initialized and the telescope has been aligned.
2. After the telescope is aligned, "Select Item: Object" displays. (If necessary, use the Scroll keys to scroll through the menus, as previously described, to find this option.) Press ENTER.
3. "Object: Solar System" displays. Keep pressing the Scroll Up key until "Object: User Object" displays and press ENTER.
4. "User Object: Select" displays. Press the Scroll Down key once. "User Object: Add" displays. Press ENTER.
5. "Name" displays on the top line and a blinking cursor on the second line. Use the Arrow keys, as previously described, to enter the name of the object you wish to add to the database. When you are finished, press ENTER.
6. "Right Asc.: 00.00.0" displays. Use the Number keys to enter the digits for the Right Ascension coordinate of your object. When you are finished, press ENTER.
7. "Declination: +00°.00'" displays. Use the Number keys to enter the digits for the Declination coordinate of your object. If necessary, use the Scroll Keys to change "+" to "-". When you are finished, press ENTER.
8. AudioStar then prompts you to enter the size of the object. This step is optional. Use the Number keys to enter the size (in arc-minutes), if so desired, and press ENTER to go to the next display. If you do not wish to enter this information, simply press ENTER.
9. AudioStar then prompts you to enter the magnitude of the object. This step is also optional. Use the Number keys to enter this information, if so desired, and press ENTER to go to the next display. "User Object: Add" displays again.

To GO TO a user-entered object:

In this procedure, you will choose an object from the User Object list and GO TO the object.

1. With "User Object: Add" displayed, press the Scroll Up key once. "User Object: Select" displays. Press ENTER.
2. Use the Scroll keys (if necessary) to scroll to the desired object. Press ENTER.
3. The name of the object and the Right Ascension and Declination coordinates display.
4. Press GO TO and the telescope slews to the object.

Observing Satellites

In this procedure, you will prepare your telescope to observe a satellite pass.

1. Navigate to the “Object: Satellite” menu option and press ENTER.
2. Use the Scroll keys to scroll through the list of satellites.
3. Select a satellite from list and press ENTER.
4. “Calculating...” and then “Tracking...” displays. If the satellite is going to make a pass, “Located” displays.
5. Use the Scroll keys to display data about the pass: aos—acquisition of signal and los—loss of signal. If you subtract the aos from the los, you can calculate how long the satellite will be visible. Location information also displays.
6. “Alarm” displays after the location information. Press ENTER and AudioStar automatically sets the alarm to sound a minute before the satellite’s scheduled appearance. You may return to regular observations until the alarm goes off.
7. When the alarm goes off, return to the Satellite menu and press a Scroll key until the desired satellite is on the top line of the display.
8. Press GO TO. AudioStar slews the telescope to where the satellite should appear. The motor drive stops and a countdown is displayed.

Note: If the scheduled appearance position of the satellite is obstructed (i.e., by a building, tree, or hill), press ENTER and AudioStar starts to move the telescope along the expected satellite track. When the track clears the obstruction, press ENTER again to pause the telescope, then continue with this procedure.

9. With about 20 seconds left on the countdown timer, start watching through the telescope viewfinder (Pg. 15, Fig. 1, 5 or Pg. 18, Fig. 12, 5) for the satellite to enter the field of view.
10. When the satellite enters the viewfinder field of view, press ENTER. The telescope starts to track with the satellite.
11. Use the AudioStar Arrow keys to center the

object in the viewfinder, then look through the eyepiece to view the object.

Satellite orbits change and new satellites are launched. Visit the Meade web site (www.meade.com) approximately once a month to get updated information and instructions on how to download this data to AudioStar. If orbital parameters are more than one month old, the satellite pass may not happen at the time predicted by AudioStar. Downloading requires the optional #505 AstroFinder™ Software and Cable Connector Kit. See OPTIONAL ACCESSORIES, page 44.

NOTE: Satellite observing is an exciting challenge. Most satellites are in low orbit, traveling at approximately 17,500 mph. When visible, they move quickly across the sky and are only in the field of view for a few minutes, requiring AudioStar to slew the telescope rapidly. Best viewing is near Sunrise or Sunset when the sky is still dark. Viewing in the middle of the night can be problematic because the satellite may pass overhead, but not be visible as it is in the Earth’s shadow.

How to Create Your Own Guided Tour

When a Guided Tour is selected, AudioStar slews your telescope to a predetermined list of objects and displays information about each object, such as type of object, constellation location, R.A. and Dec. coordinates, and so forth. AudioStar contains a few Guided Tours which are programmed at the factory. But it is also possible for an observer to create a custom Guided Tour.

A tour is basically an ASCII text file that contains a list of directions and descriptions. Each line of a tour is either a comment line, a command line, or a description.

What you will need:

- A PC with text editor or word processing software installed (the tour must be saved as a “text only” or as a “MS-DOS text” file).
- The Meade #505 Cable Connector Kit to download

tour information to the AudioStar handbox.

Tour Modes

The objects chosen for a tour list are selected from AudioStar's database or by entering the object's R.A. and Dec. coordinates. The tour is presented in one of two modes:

Automatic Mode: The title of an object appears on first line and descriptive text scrolls on line 2.

Interactive Mode: Tour name appears on the first line of the AudioStar display and the name of the object displays on line 2. To display descriptive text in this mode, the user must press ENTER.

Comment Line

Information in the Tour program that is not displayed, such as authorship, revision history, copyrights, etc. All comments begin with a "/" character in column 1 of the line. For example:

```
/ Extreme Object
```

```
/ (c) 2015 Meade Instruments Corp
```

Command Line

This line contains programming commands, including: R.A. and DEC. coordinates, a title string, a description string, and a keyword.

R.A.: Enter the Right Ascension of an object in the following format: HH:MM:SS.

Eg., 18:51:05

Dec.: Enter the Declination of an object in the following format: DDdMMmSSs. Eg., -06d16m00s

Title String: Text within a title string is displayed as the title of the object. A title string can contain up to 16 characters and must be surrounded by quotation marks. For example, "M64" or "My Favorite Star".

In **Interactive Mode**, the title string appears on line 2 until it is selected with the ENTER key.

In **Automatic Mode**, or after Interactive Mode selection, the title string appears on line 1 while the description scrolls across line 2.

Keywords: Action to be performed during a tour.

AudioStar recognizes the following keywords:

TITLE	TEXT
USER	NGC
IC	SAO
MESSIER	CALDWELL
PLANET	MOON
SATELLITE	ASTEROID
COMET	LUNAR ECLIPSE
METEOR SHOWER	DEEP SKY
CONSTELLATION	STAR
LANDMARK	DEFINE
PICK ONE/PICK END	AUTO SLEW ON/OFF
#END	

Description String: Description of an object. Must be surrounded by quotation marks. If the description is longer than one line, each line must end with a quotation mark and a hard return. Begin the next description line with a quotation mark.

If quotation marks are to be displayed in the on-screen description, use two quote marks at the beginning and end of the desired phrase. For example: "The Orion Nebula is considered "awesome" by many who view it".

Writing a Tour

Using the list of commands listed above, a custom tour can be created. Placing the word AUTO SELECT before any of the command lines activates Automatic Mode and, when selected, AudioStar automatically searches and finds the designated object.

The following is a list of command lines, complete with keywords and necessary strings:

TITLE

Title must be the first keyword in your tour after any comment lines and must be 15 characters or less. AudioStar displays this title when "Guided Tour" is selected from the menus.

For example: TITLE "A Star's Life"

TEXT "title string" "description string"

This command allows you to display a text title and description.

USER ra dec “title string” “description string”

This command line allows you to access a specific object with your own description. Enter USER, then the R.A. and DEC. of a desired object, and its title and description. Use the format described in the Command Line section.

The following commands specify objects that are already in the AudioStar database. If these commands follow the command AUTO SELECT, the object’s title displays on line 1 and its description scrolls across line 2.

Do not add a description string after the following command lines; these commands access objects with existing description in the AudioStar database.

NGC xxxx

Enter NGC followed by the desired New General Catalog number and AudioStar provides the user with a description of the object from its database. For example: NGC 4256

IC xxxx

Enter IC followed by the desired Index Catalog number and AudioStar provides the user with a description of the object from its database. For example: IC 1217

SAO xxxxxx

Enter SAO followed by the desired SAO number and AudioStar provides the user with a description of the object from its database. For example: SAO 30200

Messier xxx

Enter MESSIER followed by the desired Messier number and AudioStar provides the user with a description of the object from its database. For example: M 101

CALDWELL xxx

Enter CALDWELL followed by the Caldwell number and AudioStar provides the user with a description

of the object from its database. For example: CALDWELL 17

PLANET “name”

Enter PLANET and then the name of the desired planet in quotes. AudioStar provides the user with a description of the selected planet from its database. For example: PLANET “Pluto”

MOON

This command accesses information about the Moon from the AudioStar database.

SATELLITE “name”

Enter SATELLITE and then the name of the desired satellite in quotes. AudioStar displays

Information about the satellite from its database. For example: SATELLITE: “Intl Space Strn”

ASTEROID “name”

Enter ASTEROID and then the name of the desired asteroid in quotes. AudioStar displays information about the asteroid from its database. For example: ASTEROID: “Ceres”

COMET “name”

Enter COMET and then the name of the desired comet in quotes. AudioStar displays information about the comet from its database. For example: COMET: “Halley”

LUNAR ECLIPSE

If LUNAR ECLIPSE is part of the tour, AudioStar checks its database every time the tour is activated to see if a lunar eclipse is visible that evening. If no eclipse is visible, this option is skipped and the tour proceeds on the next object.

METEOR SHOWER

If METEOR SHOWER is part of the tour, AudioStar

checks its database every time the tour is activated to see if a meteor shower is visible that evening. If no meteor shower is visible, this option is skipped and the tour proceeds on to the next object.

DEEP SKY “name”

Enter DEEP SKY followed by the name of the desired object in quotes. For example:

DEEP SKY “Small Magellanic Cloud”

CONSTELLATION “name”

Enter CONSTELLATION followed by the name of the desired constellation in quotes. For example:
CONSTELLATION “Leo Major”

STAR “name”

Enter STAR followed by the name of the desired star in quotes. For example: STAR “Vega”

LANDMARK az alt “title” “description”

Enter the azimuth (az) for the desired object in the following format: xxxdxxmxxs. For example: 123d27m00s. Then enter the altitude of the desired object in the following format: xdxmxxs. Then enter the title string and description string in quotes. For example:

LANDMARK 123d27m00s 57d20m20s “Landmark 1”
“North corner of apartment building”

PICK ONE / PICK END

These two statements are used to surround a list of items that AudioStar can choose from during a tour. AudioStar begins at the top of the PICK ONE list and displays the first object from the list that is above the horizon and ignores the rest.

This statement is useful for developing tours that can be presented year round. For each object type you wish to use to illustrate in your tour, pick 10 to 12 examples spaced across the range of right ascension. Bracket them by the PICK ONE / PICK END statements. One current example displays for the user. For example:

AUTO SELECT TEXT “Globular Cluster” “Globular clusters are huge balls of stars”.

“They contain 50,000 to 100,000 stars and are located on the fringes of our “galaxy”.

PICK ONE

AUTO SELECT MESSIER 13

AUTO SELECT MESSIER 15

AUTO SELECT MESSIER 92

AUTO SELECT MESSIER 4

AUTO SELECT MESSIER 68

AUTO SELECT NGC 1234

AUTO SELECT TEXT “None Available” “I’m sorry. There are no bright globular” “clusters visible at this time”.

PICK END

AUTO SLEW ON / AUTO SLEW OFF

With AUTO SLEW ON enabled in the tour, AudioStar automatically slews the telescope to objects first before displaying the text description. This feature is useful when designing tours in which observing certain objects is required. For example, an astronomy professor may require his students to observe six objects, four of which AudioStar automatically slews to in a tour. The students would have to manually slew to the last two objects. He would then place AUTO SLEW ON before his first required object and AUTO SLEW OFF after the fourth object.

#END

To end a tour, type the command #END on a separate line at the very end of the tour.

Downloading Tours

Once a tour is written and stored as an ASCII file (saved either as a “text only” or “MS DOS text” file), load it into AudioStar using the AudioStar Update Utility on your PC. As tours are downloaded into the handbox, AudioStar

examines the programming. If it doesn't understand the terminology used within a tour, it flags questionable areas and displays them in a pop-up window on your computer screen. Make the necessary corrections and try to download again. See the instruction sheet with your #505 Cable Connector Kit for more information about downloading data to and interfacing with AudioStar.

Landmarks

This menu option allows you to define and store terrestrial objects in the Landmark database. First, a landmark needs to be stored in memory using the "Landmark: Add" option. To view a landmark, use the "Landmark: Select" option. Landmarks may also be viewed using the "Landmark Survey" option in the Utilities menu.

To Add a landmark to the database:

In this procedure, you will store the location of terrestrial landmarks in AudioStar's memory.

1. Set the telescope in the home position, if necessary. Note for future reference where the telescope is located and if you have aligned the telescope, which alignment method is used.

IMPORTANT NOTE: To use the Landmark function, the telescope must be located and aligned exactly as when the landmark) was added to the database.

2. Display the "Setup: Targets" menu option. Choose "Terrestrial" and press ENTER – "Setup: Targets" displays again. Choosing this option turns off tracking for astronomical objects and is not useful for the viewing of terrestrial objects such as those in the Landmark database. Be sure to change this option back to "Astronomical" when you wish to view celestial objects again.
3. Press MODE once. "Select Item: Setup" displays.
4. Press the Scroll Down key once and "Select Item: Object" displays. Press Enter. "Object: Solar System" displays.

5. Press the Scroll Up key twice and "Object: Landmarks" displays. Press ENTER. "Landmark: Select" displays.
6. Press the Scroll Down key once. "Landmark: Add" displays. Press ENTER.
7. "Landmark Name" displays. Using Arrow keys, enter a name for the landmark you wish to add to the database. When finished, press ENTER.
8. "Center Landmark. Press Enter" displays. Using only the Arrow keys (do not manually move the telescope), move the telescope to the desired landmark and center the object in the eyepiece. Press Enter. The object is now stored in memory.
9. "Landmark: Add" displays. If you wish to add more landmarks, repeat steps 5 through 7.

To Select a landmark from the database:

1. Make sure the telescope is located and aligned exactly as when the desired landmark was entered into memory.
2. Display the "Landmark: Select" menu option. Press ENTER.
3. Use the Scroll keys to scroll through the list of objects you have previously entered. When the desired object displays, press ENTER to select the object. Use the Scroll keys to scroll through location information about the object, if desired. Press GO TO to slew the telescope to the landmark.
4. Press MODE to exit.

To perform a Landmark Survey

This procedure allows you to perform a tour of the objects entered in the "Object: Landmark" menu option – note that the Landmark Survey will function only if you have previously entered objects in the Landmark menu.

1. Navigate to "Utilities: Landmark Survey" menu and press ENTER.
2. "Landmark Survey: Slewing..." displays. The telescope moves to the first object on the

Survey list and displays the name of the object.

3. Press MODE to pause the Survey. Press Enter to restart the survey at the first object of the survey.

To check on the available amount of memory in AudioStar.

AudioStar has a limited amount of memory. Once you begin to store Landmarks, User Objects and other bits of information in AudioStar, you will begin to use up memory. This procedure allows you to check on how much memory is still available.

1. Navigate to the “Setup: Statistics” menu option and press ENTER.
2. “Statistics: 97.4K Char. Free” displays. This is the amount of memory that is still available to the user.

Identify

This procedure allows you to use AudioStar to identify objects you have found in the night sky using the Arrow keys. If the object is not in AudioStar’s database, AudioStar displays information about an object in its database that is closest to the one you queried about.

Important Note: The telescope must be successfully aligned before the Identify feature can be used. Once aligned, it cannot be physically moved from that location. Moving the telescope disrupts the telescopes frame of reference to the night sky and will prevent it from identifying objects.

In this procedure, you will center an object you wish to have identified by AudioStar in the telescope eyepiece and use the “Identify” menu to find out information about the object or the nearest object to it in the AudioStar database.

1. Center the object you wish to have identified in the telescope’s eyepiece.
2. Navigate to the “Object: Identify” option and

press ENTER.

3. “Searching...” displays. When AudioStar finishes calculating, the name of the closest object displays.
4. Press a Scroll key to display information about this object. AudioStar displays some or all the following information about the object with each press of a Scroll key:

Displayed information:	Example:
Catalog or common name...	Messier 107, NGC 6171, Orion Nebula, etc
Type of object.....	Globular Cluster, Nebula, Black Hole, etc.
Right Ascension.....	16:32:4
Declination.....	13°03’
Constellation	Virgo, Orion, etc.
Magnitude.....	3
Size.....	2’
Scrolling message.....	“This Globular Cluster is 10,000 light years away...”

Advanced Alt/Az Alignment

If you would rather choose your own alignment stars from the AudioStar database during the Alt/Az alignment procedure, AudioStar offers two methods described below.

Two-Star Alt/Az Alignment

Two-Star Alignment requires some knowledge of the night sky. AudioStar provides a database of bright stars and two stars from this database are chosen by the observer for alignment.

1. Turn the telescope on: Turn the telescope power switch to the ON position. The AudioStar beeps and the display screen is activated. AudioStar then takes a few moments to start up the system.
2. Select Alignment Procedure: "Press 0 to Align or Mode for Menu" displays. Press "Mode" to access the AudioStar menu.
3. Testing Motors: The telescope then tests the motor function of the telescope by moving in the horizontal and vertical directions.
4. Set Your Location or Zip Code: The Location screen displays. This screen asks you if you wish to choose either the zip code of your observing location or the location (i.e., entering the city and state or country of your observing location). Press "1" to select the zip code option or "2" to enter the city and state.

Note: The location settings (country/state/province and city, or zip code) are only asked for the first time you turn on the control panel. If you wish to change this setting later on, use the Site menu. See SITE, page 32 for more information.

- A. If you chose the zip code option, the left most "0" is highlighted. Use the Number keys to enter the digits. As you enter a digit, the next digit to the right will be highlighted. Enter the next digit. Repeat this process until all 5 digits of your zip code are entered. Press ENTER.
- B. If you chose the location option, the next screen asks for the country or state/province (listed alphabetically) of the observing site.

C. Use the Scroll keys to scroll through the list of countries, states, and provinces. Press ENTER when the correct location displays.

D. The next screen asks for the city (listed alphabetically) closest to the observing site. Use the Scroll keys to scroll through the list of cities. Press ENTER when the correct city appears on screen.

5. Daylight Savings Time: The next screen requests the status of Daylight Savings Time. If Daylight Savings Time is active, press the 1 key. If Daylight Savings Time is not active, press the 2 key.

Note: Daylight Savings Time may be referred

ETX OBSERVER TIPS

Too Much Power?

Can you ever have too much power? If the type of power you're referring to is eyepiece magnification, yes, you can! The most common mistake of the beginning observer is to "overpower" a telescope by using high magnifications which the telescope's aperture and atmospheric conditions cannot reasonably support. Keep in mind that a smaller, but bright and well-resolved image is far superior to one that is larger, but dim and poorly resolved (see Figs. 23a and 23b below). Powers above 175x should be employed only under the steadiest atmospheric conditions.

Most observers should have three or four additional eyepieces to achieve the full range of reasonable magnifications possible with the ETX telescopes. See OPTIONAL ACCESSORIES, page 44.

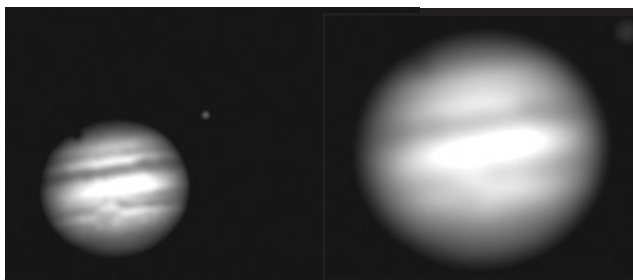

Figs. 23a & 23b: Jupiter; examples of the right amount of magnification and too much magnification.

to by a different name in various areas of the world.

6. Telescope Model: AudioStar then asks for the Telescope Model. Using the scroll keys (Pg. 22, Fig. 19a, 7) on the AudioStar locate the model of your telescope and press enter.
7. The ETX 90 is equipped with an internal time chip and will know the correct time and date right out of the box. However, if you need to change these values they are found in the setup menu. See page 31 for more information.
8. With "Align: Easy" displayed, use the Scroll Keys to display "Align: Two Star". Press Enter.
9. AudioStar will now describe the correct home position for the telescope. Once the telescope is in the correct home position, press ENTER. See page 9 for more information.
10. "Select Star" displays. AudioStar then displays a database of stars for the observer to choose from. Use the Scroll keys to scroll to a star on the list that you wish to align upon. Select a star that you can easily locate in the night sky. Press ENTER.
11. The telescope slews to the star. Use the Arrow keys to move the telescope until the star is centered in the eyepiece. Press ENTER.
12. Repeat procedure for the second alignment star. The telescope is aligned and you are now ready to use AudioStar's GO TO capabilities for a night of observing.

One-Star Alt/Az Alignment

One-Star Alignment requires some knowledge of the night sky. AudioStar provides a database of bright stars. One-Star Alignment is identical to Two-Star Alt/Az: Alignment (see "Two-Star ALT/AZ Alignment," above), except only one star from this database is chosen by the observer for alignment.

IMPORTANT NOTE : The accuracy of One-Star Alt/Az Alignment, unlike the Two-Star and Easy (Alt/Az) Alignment procedures, depends on how well the observer levels the telescope and how close to North the telescope is pointed

when setting the Home Position (Pg. 9, Fig. 1). Because the other methods use two stars to align upon, they are more precise than One-Star Alignment.

Browse

This menu allows you to search the database for objects with certain parameters, much like a search engine. "Edit Parameters" lets you set various parameters for the search, and "Start Search" activates the search. A typical search might be performed as follows:

1. Select "Browse" from the Object menu. Press ENTER. "Browse: Start Search" displays.
2. Press one of the Scroll Keys and "Browse: Edit Parameters" displays. Press Enter.
3. "Edit Parameters: Largest (mins)" displays. "Mins" stands for arc-minutes. Press ENTER.

OPTIONAL ACCESSORIES

Meade makes a complete line of accessories to enable you to get the most fun and performance from your ETX Series telescope. No matter what you want to accomplish, we have the equipment to help you get there.

Choosing Eyepieces

A telescope's eyepiece magnifies the image formed by the telescope's main optics. Each eyepiece has a focal length, expressed in millimeters, or "mm." The smaller the focal length, the higher the magnification. For example, an eyepiece with a focal length of 9mm has a higher magnification than an eyepiece with a focal length of 26mm. Experienced users know that higher powers are, in general, not as useful as lower powers. Many of the objects in the night sky are relatively large and faint and look best at low magnifications.

The power or magnification of a telescope is determined by the focal length of the telescope and the focal length of the eyepiece being used. To calculate magnification, divide the telescope's focal length by the eyepiece's focal length. For example, a 26mm eyepiece is supplied with the ETX 90. The focal length of the ETX 90 is 1250mm (see SPECIFICATIONS, pages 53 and 54).

Telescope Focal Length 1250mm

Eyepiece Focal Length 26mm

$$1250 \div 26 = 48.1x$$

The magnification is therefore 48.1x.

Low power eyepieces offer a wider field of view, bright, high-contrast images, and long eye relief. To find an object with a telescope, always start with a lower power eyepiece such as the Super Plössl 26mm or longer focal length. When the object is located and centered in the eyepiece, you may wish to switch to a higher power eyepiece to enlarge the image as much as practical for prevailing seeing conditions or, for many objects, the view is best with a high quality low-power wide-field eyepiece.

NOTE: Seeing conditions vary widely from night-to-

night and site-to-site. Turbulence in the air, even on an apparently clear night, can distort images. If an image appears fuzzy and ill-defined, reduce to a lower power eyepiece.

Your telescope comes supplied with a Super Plössl 26mm & 9.7mm eyepiece. These are very good all purpose eyepieces for your telescope, but you should consider buying additional eyepieces in longer and shorter focal lengths to fully realize the potential of the excellent ETX optical system.

The Series 4000 Super Plössl Eyepieces are excellent well corrected 4 element optics at popular prices. They come in a wide range of focal lengths to give you the right magnification for any type of celestial object you are viewing.

You can also use one of the Series 4000 Barlow's to double or triple the magnification of a Super Plössl eyepiece. These eyepieces have been the standard for over 30 years.



Power Supplies

While the ETX will operate with “AA” cell batteries, several alternative power options are available.



#546 AC Adapter (07576). This adapter supplies 12 volt DC from a standard 115 volt AC household supply. Connects via the 9v connector in the battery compartment.



12 Volt Universal AC Adapter(07584): Supplies 12 volts DC from a standard 115 volt AC household supply. It is regulated to output 12volts and has a maximum 5 amp output. Connects via the control panel.



LXPS Portable DC Power Supply (606001 or 606002): A portable rechargeable power source to operate you ETX in the field. Lead-acid battery offered in 7 or 17 amp-hour capacities.



Meade #607 DC Power Cord w/Cigarette Lighter Adapter (#07043) Lets you power the ETX Observer from a car cigarette lighter style power socket. Offering convenient power on the go, this item is great for saving batteries and for extended star parties. Includes a 25 foot extension cord.

Other Accessories



#64 or #64ST T-Adapter. The basic means of photography through any ETX telescope. ETX 80 users will use the #64ST T-Adapter. ETX 90 & 125 users will use the #64 T-Adapter. Both thread to the rear cell photo port of the telescope, followed by a T-Mount appropriate to the user’s brand of 35mm or DSLR camera. In this way, the camera body is rigidly coupled to the telescope’s optical system, which in effect becomes the camera’s lens.

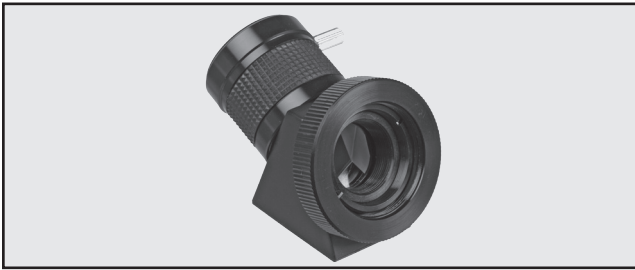

#932 or #933 45° Erecting Prism. All ETX models include an internal optically-flat mirror to reflect light to the telescope's 90° astronomical observing position. In this position the telescope's image is upright, but reversed. For terrestrial observing with an ETX model, the 45° Erecting Prism correctly orients the eyepiece image and provides a convenient observing angle. ETX 80 users will use the #933 45° Erecting Prism. ETX 90 & 125 users will use the #932 45° Erecting Prism.

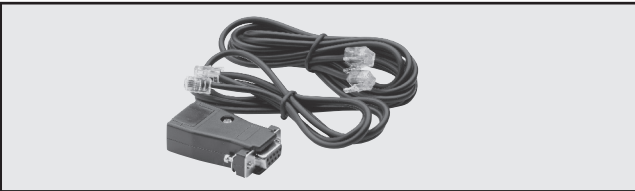

#505 Connector Cable Set. For all AudioStar controlled telescopes. Allows you to connect your ETX Telescope to a PC serial port. Operate your computer from your PC, download updates, create custom tours and more.

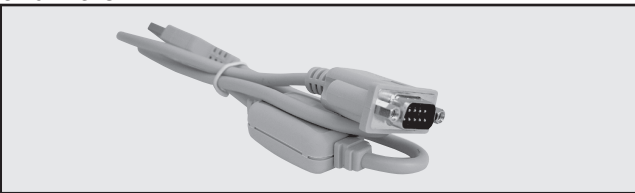

USB to Serial Bridge Cable. Allows you to use #505 or #506 cables above to connect to a USB port. Driver software included. Windows 98, ME, 2000, XP and Win7 compatible.

Accessories at Meade.com. Now you can order all these and more accessories or any Meade products right from the Meade Web Site www.meade.com and it will be shipped right to your door.

MAINTENANCE

Your ETX model telescope is a precision optical instrument designed to yield a lifetime of rewarding observations. Given the care and respect due any precision instrument, the telescope will rarely require factory servicing or maintenance. Use the following guidelines:

1. Avoid cleaning the telescope's optics: a little dust on the front surface of the telescope's correcting lens causes virtually no degradation of image quality and should not be considered reason to clean the lens.

2. When absolutely necessary, remove dust from the front lens with gentle strokes of a camel-hair brush or blow it off with an ear syringe (available at any pharmacy). Do not use a commercial photographic lens cleaner.

3. You may remove organic materials (e.g., fingerprints) from the front lens with a solution of 3 parts distilled water to 1 part isopropyl alcohol. A single drop of biodegradable dish washing soap may be added per pint of solution. Use soft, white facial tissues and make short, gentle strokes. Change tissues often.

Caution: Do not use scented, colored or lotioned tissues or damage could result to the optics.

4. In the very rare situation where cleaning the inside surface of the corrector lens becomes necessary, unthread the lens cell located at the front of the main tube. The entire correcting lens and secondary mirror system are mounted in this cell. You may use the lens-cleaner solution described in step 3 to clean the inside surface of the lens.

Caution: For ETX 90/125 users: Do not touch the aluminized circular surface of the secondary mirror with a finger, a tissue or any other object. This will almost certainly scratch the mirror surface.

Note: For ETX 90/125 users: When cleaning the inside surface of the correcting lens, leave the lens mounted in its metal cell throughout the process. Do not remove the lens from its metal housing or optical alignment of the lens will be lost.

5. If your ETX model is used outdoors on a humid night, telescope surfaces may accumulate water condensation. While such condensation does not normally cause any damage to the telescope, it is recommended that the entire telescope be wiped down with a dry cloth before being packed away. Do not, however, wipe any of the optical surfaces. Rather, simply allow the telescope to sit for some time in warm indoor air, so that the wet optical surfaces can dry unattended. In addition, the dust cap should not be placed back on to the optical tube until the telescope is thoroughly dry.

6. If your ETX model is not to be used for an extended period, perhaps for one month or more, it is advisable to remove the eight AA-size batteries from inside the drive base. Batteries left installed for prolonged periods may leak, causing damage to the telescope's electronic circuitry (see Assembling the tripod, page 5).

7. The super-gloss painted finish of any ETX model's optical tube may fade if left in direct sunlight for prolonged periods.

8. Do not leave your ETX model outdoors on a warm day or inside a sealed car for an extended period of time; excessive ambient temperatures can damage the telescope's internal lubrication and electronic circuitry.

Storage and Transport

When the telescope is not in use, store it in a cool, dry place. Do not expose the instrument to excessive heat or moisture. It is best to store the telescope in its original box with the vertical and horizontal locks (Pg. 14 , Fig. 5, 10 and and Pg. 15, Fig. 8, 18) in the unlocked positions. If shipping the telescope, use the original box and packing material to protect the telescope during shipment.

When transporting the telescope, take care not to bump or drop the instrument; this type of abuse can damage the optical tube and/or the objective lens and knock the optics out of alignment.

Inspecting the Optics

A few words about the so-called “flashlight test”: If a flashlight or other high-intensity light source is pointed down the main telescope tube, the view (depending upon the observer’s line of sight and the angle of the light) may reveal what appear to be scratches, dark or bright spots or uneven coatings, giving the appearance of poor quality optics. These effects are only seen when a high intensity light is transmitted through lenses or reflected off the mirrors and can be seen on any high-quality optical system, including giant research telescopes.

The optical quality of a telescope cannot be judged by the “flashlight test”; the true test of optical quality can only be conducted through careful star testing.

Troubleshooting

The following suggestions may be helpful with operation of the ETX Observer telescopes.

The power indicator light on the telescope does not come on or there is no response when pressing the AudioStar Arrow keys:

- Verify that the Computer Control panel power switch (Pg 15, Fig. 11, 12c) is in the ON position.
- Verify that the AudioStar coil cord is firmly connected to the HBX port (Pg 15, Fig. 11, 12a).
- If using internal power (batteries), verify that the batteries are installed correctly and that they have sufficient charge (see Installing the Batteries, page 7).

Note: If the batteries are getting low on charge, there will be a marked difference in the slew speed. The speed indicator lights may also flash and the speed may change. If any of these symptoms occurs, turn the power off and replace the batteries.

- If using an external power source, verify that it is properly connected between the power connector and wall plug (AC source) .
- If AudioStar does not respond to commands, move the power switch to OFF and then back to ON.
- If the telescope does not slew after power is applied or if the motor quits or stalls, verify that there are no physical obstructions that would impede telescope movement.
- If all physical obstacles are removed and the telescope still does not move properly, turn off the power and unplug AudioStar. Plug AudioStar back in and turn the power back on.

Unable to see an image through the eyepiece:

- Confirm that the lens cover has been removed from the telescope.
- Confirm that the flip-mirror control (Pg 15, Fig. 6, 14) is in the “up” position if using the eyepiece holder (Pg 14, Fig. 5, 3 so that light is directed to the eyepiece. Confirm that the flip-mirror control is in the “down” position if using the #932 or #933 Erecting Prism or doing photography with an ETX model.

Object appears in the viewfinder but not in the eyepiece:

- The viewfinder is not properly aligned with the telescope (see ADJUSTING THE VIEWFINDER, page 9).

Slew speed does not change when you change slew speeds or the telescope moves slowly even though the fast slew speed is chosen:

- The battery power may be low. Replace all batteries with fresh, new units.

Telescope does not track a celestial object:

- Make sure that the telescope is correctly aligned. See Easy (Two-Star) Align, page 11, for more information.

- Verify the telescopes date, time, location, daylight savings time, and telescope model are correct.
- Reset the telescope to the factory defaults. Go to Setup/Reset and press enter.
- Adjust the AZ/RA Percent and/or Alt/DEC Percent values found in the Setup/Telescope menu. See page 31 & 32 "Az Percent" & "Alt Percent" for more information.

A terrestrial object appears reversed left-for-right:

- An eyepiece in the standard 90° observing position reverses an object left-for-right: To view a correctly oriented image requires the optional 45° Erecting Prism (see page 46).

Images through the eyepiece appear unfocused or distorted:

- The magnification may be too high for the viewing conditions. Back off to a lower power eyepiece (see "Eyepiece Calc", page 30) and "Choosing Eyepiece" page 44.
- If inside a warm house or building, move outside. Interior air conditions may distort terrestrial or celestial images, making it difficult, if not impossible, to obtain a sharp focus. For optimal viewing, use the telescope outside in the open air instead of observing through an open or closed window or screen.
- If viewing a land object on a warm day, heat waves will distort the image (see Terrestrial Observing, page 25).
- For clear viewing of objects, turn the focus knob slowly since the "in-focus" point of a telescope is precise. Turning the focus knob too quickly may cause the focus point to pass without notice.
- The optics within the telescope need time to adjust to the outside ambient temperature to provide the sharpest image. To cool down the optics, set the telescope outside for 10 to 15 minutes before observing begins.

Telescope moves off a terrestrial object while observing:

- Verify that the vertical and horizontal locks are tight (see ETX KEY FEATURES, page 14 or page 18 depending on your telescope model).

Telescope pauses when changing slew direction:

- This pause is normal.
- Perform the "Training the Drive" routine. See Appendix A: Training the Drive" on page 50.

APPENDIX A: TRAINING THE DRIVE

Perform this procedure if you are experiencing any pointing accuracy problems. Fig. 24 depicts the complete Drive Training procedure.

NOTE: Use a far away terrestrial object, such as a telephone pole or lamp post, to train the drive. A high power reticle (cross hair) eyepiece is recommended.

Complete this exercise once every 3 to 6 months, or when the AudioStar handbox has been reset to the factory defaults.

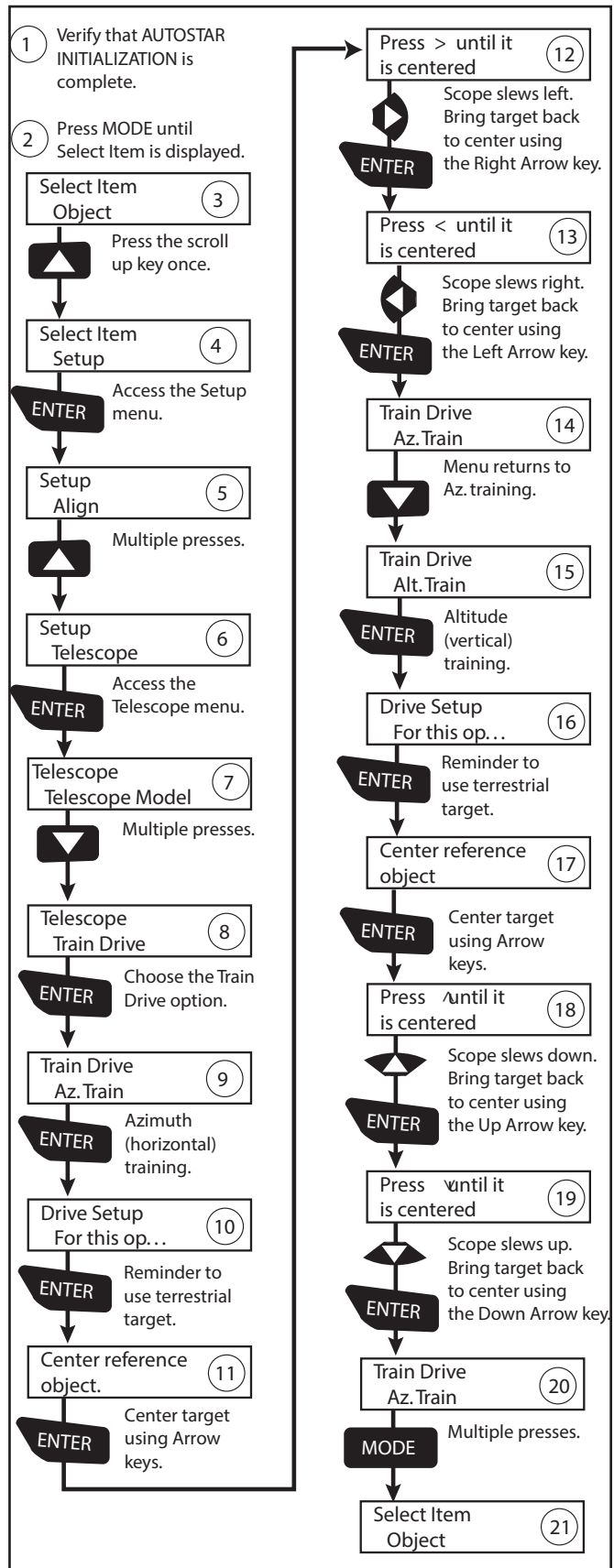

Figure 24: Training the Drive

APPENDIX B:

BASIC ASTRONOMY

In the early 17th century Italian Scientist Galileo, using a crude telescope considerably smaller than the ETX 80, turned it to look towards the sky instead of distant trees and mountains. What he saw, and what he realized about what he saw, forever changed the way mankind thought of the universe. Imagine what it must have been like being the first human to see moons revolve around the planet Jupiter or to see the changing phases of Venus! Because of his observations, Galileo correctly realized Earth's movement and position around the Sun, and in doing so, gave birth to modern astronomy. Yet Galileo's telescope was so crude, he could not clearly make out the rings of Saturn.

Galileo's discoveries laid the foundation for understanding the motion and nature of the planets, stars, and galaxies. Building on his foundation, Henrietta Leavitt determined how to measure the distance to stars; Edwin Hubble proposed a glimpse into the origin of the universe; Albert Einstein unraveled the relationship of time and light. Almost daily, using sophisticated successors to Galileo's crude telescope, such as the Hubble Space Telescope, more and more mysteries of the universe are being solved and understood. We are living in a golden age of astronomy.

Unlike other sciences, astronomy welcomes contributions from amateurs. Much of the knowledge we have on subjects such as comets, meteor showers, variable stars, the Moon and our solar system comes from observations made by amateur astronomers. So as you look through your Meade ETX 90 telescope, keep Galileo in mind. To him, a telescope was not merely a machine made of glass and metal, but something far more - a window through which the beating heart of the universe might be observed.

Objects in Space

Listed below are some of the many astronomical objects that can be seen with the ETX



The Moon is, on average, a distance of 239,000 miles (380,000km) from Earth and is best observed during its crescent or half phase when Sunlight strikes the Moon's surface at an angle. It casts shadows and adds a sense of depth to the view. No shadows are seen during a full Moon, causing the overly bright Moon to appear flat and rather uninteresting through the telescope. Be sure to use a neutral Moon filter when observing the Moon. Not only does it protect your eyes from the bright glare of the Moon, but it also helps enhance contrast, providing a more dramatic image.

Using the ETX, brilliant detail can be observed on the Moon, including hundreds of lunar craters and Maria, described below.

Craters are round meteor impact sites covering most of the Moon's surface. With no atmosphere on the Moon, no weather conditions exist, so the only erosive force is meteor strikes. Under these conditions, lunar craters can last for millions of years.

Maria (plural for mare) are smooth, dark areas scattered across the lunar surface. These dark areas are large ancient impact basins that were filled with lava from the interior of the Moon by the depth and force of a meteor or comet impact.

Twelve Apollo astronauts left their bootprints on the Moon in the late 1960's and early 1970's. However, no telescope on Earth is able to see these footprints or any other artifacts. In fact, the smallest lunar features that may be seen with the largest telescope on Earth are about one-half mile across.

Planets change positions in the sky as they orbit around the Sun. To locate the planets on a given day or month, consult a monthly astronomy magazine, such as Sky and Telescope or Astronomy. You can also consult ETX 90 for information about planets.

Scroll to the “Object: Solar System” menu and scroll through the lists of planets. When a planet you are interested in displays, press “ENTER”. Use the Scroll keys to display information about the planet, such as the planet’s coordinates, and the rise and set times (Tip: enter a date in the Date menu and you can determine if a planet) will be visible during the night of the entered date by checking its rise and set times). Listed below are the best planets for viewing through the ETX 90/125.

Mars is about half the diameter of Earth, and appears through the telescope as a tiny reddish-orange disk. It may be possible to see a hint of white at one of the planet’s Polar ice caps. Approximately every two years, when Mars is closest to Earth in its orbit, additional detail and coloring on the planet’s surface may be visible.

Jupiter is the largest planet in our solar system and

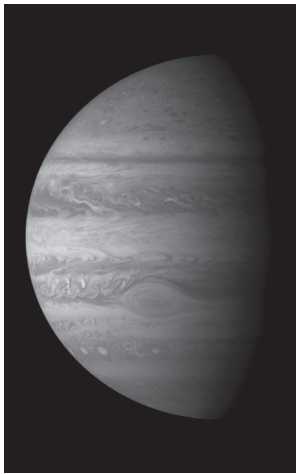

is 11 times the diameter of Earth. The planet appears as a disk with dark lines stretching across the surface. These lines are cloud bands in the atmosphere. Four of Jupiter’s 16 moons (Io, Europa, Ganymede, and Callisto) can be seen as “star-like” points of light when using even the lowest magnification. These

moons orbit Jupiter so that the number of moons visible on any given night changes as they circle around the giant planet.

Saturn is nine times the diameter of Earth and appears as a small, round disk with rings extending out from either side. In 1610, Galileo, the first person to observe Saturn through a telescope, did not understand that what he was seeing were rings. Instead, he believed that Saturn had “ears.” Saturn’s rings are composed of billions of ice particles ranging in size from a speck of dust to the size of a house. The major division in

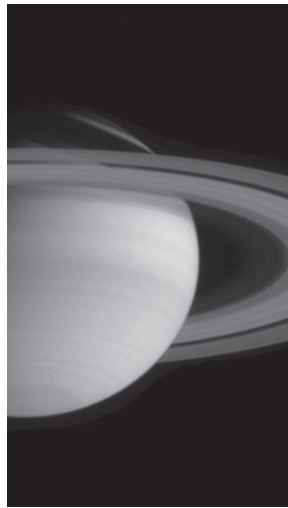

Saturn’s rings, called the Cassini Division, is occasionally visible through the ETX 90. Titan, the largest of Saturn’s 18 moons can also be seen as a bright, star-like object near the planet.

Deep-Sky Objects

Star charts can be used to locate constellations, individual stars and deep-

sky objects.

Examples of various deep-sky objects are given below:

Stars are large gaseous objects that are self-illuminated by nuclear fusion in their core. Because of their vast distances from our solar system, all stars appear as pinpoints of light, irrespective of the size of the telescope used.

Nebulae are vast interstellar clouds of gas and dust where stars are formed. Most impressive of these is the Great Nebula in Orion (M42), a diffuse nebula that appears as a faint wispy gray cloud. M42 is 1600 light years from Earth.

Open Clusters are loose groupings of young stars, all recently formed from the same diffuse nebula. The Pleiades is an open cluster 410 light years away. Through the ETX, numerous stars are visible. Constellations are large, imaginary patterns of stars believed by ancient civilizations to be the celestial equivalent of objects, animals, people, or gods. These patterns are too large to be seen through a telescope. To learn the constellations, start with an easy grouping of stars, such as the Big Dipper in Ursa Major. Then, use a star chart to explore across the sky.

Galaxies are large assemblies of stars, nebulae, and star clusters that are bound by gravity. The most common shape is spiral (such as our own Milky Way), but galaxies can also be elliptical, or even irregular blobs. The Andromeda Galaxy (M31) is the closest spiral-type galaxy to our own. This galaxy appears fuzzy and cigar-shaped. It is 2.2 million light years away in the constellation Andromeda, located between the large “W” of Cassiopeia and the great square of Pegasus.

APPENDIX C:

SPECIFICATIONS

Model and Product Number	ETX 80 Observer Back Pack Telescope # 205002
Optical System	
Optical Design	Achromatic Refractor
Front Lens Diameter	3.15" (80mm)
Front Lens Material	Optical quality glass
Focal Length, Focal Ratio	400mm, f/5
Optical Coatings	Multi-Coated
Resolving Power (arc-seconds)	1.6 arc-seconds
Limiting Visual Stellar Magnitude	11.5
Viewfinder	Red Dot
Mount	
Mount Type	Dual Fork Alt-azimuth
Power	6 "AA" Cell Batteries or AC Adapter
Battery Life (Approx)	20 hours
Tripod	Adjustable-Height Aluminum Leg Tripod
Electronics	
Controller Hand Box	AudioStar with 30,000 object database
Included Accessories	
Eyepiece	Super Plössl 26mm & 9.7mm- 1.25" size
Bubble Level/Compass	Included - 1.25" size
Astronomy Software	Included - for Windows OS
Weight	
Telescope	9 lbs.
Tripod	2.75 lbs

SPECIFICATIONS

Model and Product Number ETX 90 Observer Portable Observatory # 205004

Optical System

Optical Design	Maksutov-Cassegrain
Primary Mirror Diameter	3.5" (90mm)
Primary Mirror Material	Optical quality glass
Focal Length, Focal Ratio	1250mm, f/13.8
Optical Coatings	Ultra-High Transmission Coatings (UHTC™)
Resolving Power (arc-seconds)	1.3 arc-seconds
Limiting Visual Stellar Magnitude	11.7
Viewfinder	Red Dot

Mount

Mount Type	Dual Fork Alt-azimuth
Power	6 "AA" Cell Batteries or AC Adapter
Battery Life	20 hours
Tripod	Adjustable-Height Steel Leg Tripod with EQ tilt-plate

Electronics

Controller Hand Box	AudioStar with 30,000 object database
---------------------	---------------------------------------

Included Accessories

Eyepieces	Super Plössl 26mm and 9.7mm - 1.25" size
Bubble Level/Compass	Included - 1.25" size
Astronomy Software	Included - for Windows OS

Weight

Telescope	9.5 lbs.
Tripod	9.75 lbs
Carry Case	10 lbs

SPECIFICATIONS

Model and Product Number	ETX 125 Observer # 205005
Optical System	
Optical Design	Maksutov-Cassegrain
Primary Mirror Diameter	5" (127mm)
Primary Mirror Material	Optical quality glass
Focal Length, Focal Ratio	1900mm, f/15
Optical Coatings	Multi-Coated
Resolving Power (arc-seconds)	0.9 arc-seconds
Limiting Visual Stellar Magnitude	12.5
Viewfinder	Red Dot
Mount	
Mount Type	Dual Fork Alt-azimuth
Power	8 "AA" Cell Batteries or AC Adapter
Battery Life	20 hours
Tripod	Adjustable-Height Steel Leg Tripod with EQ tilt-plate
Electronics	
Controller Hand Box	AudioStar with 30,000 object database
Included Accessories	
Eyepieces	Super Plössl 26mm and 9.7mm - 1.25" size
Bubble Level/Compass	Included - 1.25" size
Astronomy Software	Included - for Windows OS
Weight	
Telescope	15 lbs.
Tripod	9.75 lbs

APPENDIX D:

EQUATORIAL (POLAR) ALIGNMENT

****FOR ETX 90/125 ONLY****

Equatorial Alignment

In equatorial (or “polar”) alignment, the telescope is oriented so that the horizontal and vertical axes of the telescope are lined up with the celestial coordinate system.

In order to equatorially align your telescope, it is essential to have an understanding of how and where to locate celestial objects as they move across the sky. This section provides a basic introduction to the terminology of equatorially-aligned astronomy and includes instructions for finding the celestial pole and for finding objects in the night sky using Declination and Right Ascension.

Celestial Coordinates

A celestial coordinate system was created that maps an imaginary sphere surrounding the Earth upon which all stars appear to be placed. This mapping system is similar to the system of latitude and longitude on Earth surface maps.

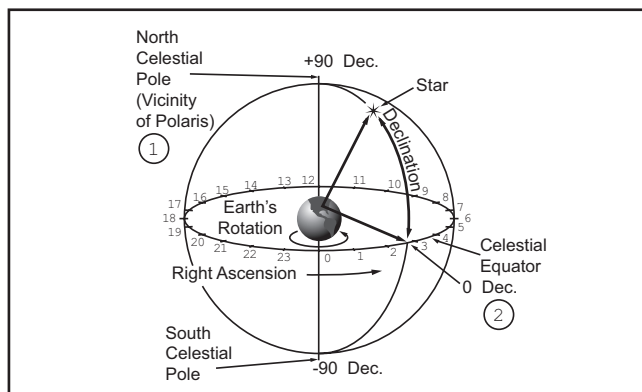

Figure 25: Celestial Sphere

In mapping the surface of the Earth, lines of longitude are drawn between the North and South Poles and lines of latitude are drawn in an East-West direction, parallel to the Earth's equator. Similarly, imaginary lines have been drawn to form a latitude and longitude grid for the celestial sphere. These lines are known as Right Ascension and Declination.

The celestial map also contains two poles and an equator just like a map of the Earth. The poles of this coordinate system are defined as those two points where the Earth's North and South poles (i.e., the Earth's axis), if extended to infinity, would cross the celestial sphere. Thus, the North Celestial Pole (Fig. 25) is that point in the sky where an extension of the North Pole intersects the celestial sphere. The North Star, Polaris, is located very near the North Celestial Pole). The celestial equator is a projection of the Earth's equator onto the celestial sphere.

So just as an object's position on the Earth's surface can be located by its latitude and longitude, celestial objects may also be located using Right Ascension and Declination. For example: You could locate Los Angeles, California, by its latitude (+34°) and longitude (118°). Similarly, you could locate the Ring Nebula (M57) by its Right Ascension (18hr) and its Declination (+33°).

- **Right Ascension (R.A.):** This celestial version of longitude is measured in units of hours (hr), minutes (min) and seconds (sec) on a 24-hour “clock” (similar to how Earth's time zones are determined by longitude lines). The “zero” line was arbitrarily chosen to pass through the constellation Pegasus, a sort of cosmic Greenwich meridian. R.A. coordinates range from 0hr 0min 0sec to 23hr 59min 59sec. There are 24 primary lines of R.A., located at 15-degree intervals along the celestial equator. Objects located further and further East of the zero R.A. grid line (0hr 0min 0sec) carry higher R.A. coordinates.

- **Declination (Dec.):** This celestial version of latitude is measured in degrees, arc-minutes and arc-seconds (e.g., 15° 27' 33"). Dec. locations North of the celestial equator are indicated with a plus (+) sign (e.g., the Dec. of the North celestial pole is +90°). Dec. locations South of the celestial equator are indicated with a minus (–) sign (e.g., the Dec. of the South celestial pole is –90°). Any point on the celestial equator (such as the constellations of Orion, Virgo and Aquarius) is said to have a Declination of zero, shown as 0° 0' 0."

Polar Mounting your Telescope with the #884 Deluxe Field Tripod

As the Earth rotates on its axis, astronomical objects appear to move across the sky in an arc. This apparent motion is not obvious to the unaided eye, but when viewed through a telescope such as an ETX, this motion is rapid indeed. If the motor drive has not been engaged, celestial objects viewed in the telescope eyepiece drift entirely out of the field of view in 15 to 60 seconds, depending on the magnification employed.

However, by mounting your telescope and turning on the motor drive, you can counteract the drift of objects in the eyepiece. The two basic types of mounting are: alt-azimuth (alt/az) and equatorial. For many ETX owners, it will not be necessary to equatorially mount the telescope; alt/az mounting will suffice. The AudioStar Controller allows the telescope to be mounted in the alt-azimuth (alt/az) mode for most observing purposes. See Easy (TWO-STAR) Align, page 11, for more information.

However, owners who wish to perform astrophotography will find equatorial mounting indispensable to their needs.

Equatorial Mount

Equatorial mounting lines up the telescope's polar axis with the North Celestial Pole (or the South Celestial Pole if observing in the southern hemisphere).

When using an equatorially mounted telescope, tracking (following) celestial objects is possible by turning on your ETX telescope's motor drive. The motor counteracts the Earth's rotation and keeps objects in the field of view of the eyepiece for hands-off tracking.

Equatorial Mounting Procedure

1. Assemble the tripod as described in Step #2 of Getting Started on page 5.
2. Loosen the latitude control latch (Fig. 27) and lift up the tilt-plate so that you can easily access the underside of the plate. Re-lock the latitude control latch, so the assembly doesn't slip while you are



Figure 26: Attach Telescope to Tripod

attaching the telescope.

3. Turn the tripod, so that the face of the tilt-plate points North (Figs. 28). If you attach the telescope to the tripod indoors, be sure to orient the face of the tilt-plate to point North after moving the telescope outdoors. Equivalently, point the tripod leg (Fig. 28) North. This is the leg opposite from the latitude control bar (Fig. 27) .

4. Line up the mounting hole on the base of the telescope

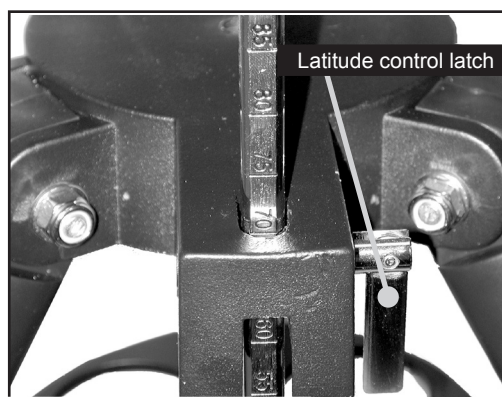

Figure 27: Set latitude

so the computer control panel faces westward. Thread both attachment knobs into the base of the telescope. Tighten to a firm-feel only.

5. Determine the latitude of your observing location from a road map, atlas or the Latitude Chart for Major Cities of the World, page 60. Loosen the latitude control latch (Fig. 27) and adjust the latitude control bar (Fig. 26) so that your observing site's latitude is just visible above the flat surface of the tripod head. Re-tighten the latch.

6. If you have not already done so orient the tripod leg (Fig. 28) so that it is pointing due North (if the location of Polaris, the North Star, is known, point the telescope directly at Polaris. Observers located in the Earth's Southern Hemisphere must point the telescope due

South).

7. The telescope is now equatorially mounted; the tripod must not be moved or else the alignment will be lost. Instead, use one of the following methods to

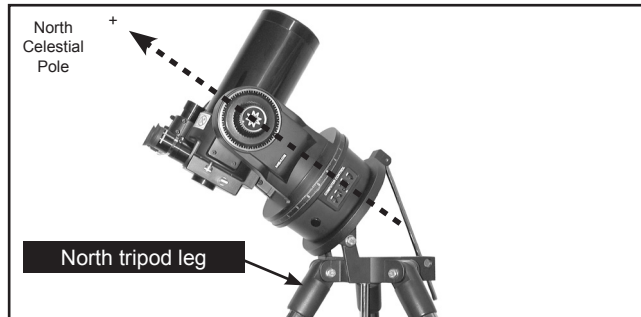

Figure 28: Example of Polar Alignment. Note that the face of the tilt-plate points north

move the telescope's optical tube to a desired celestial object.

(A) Loosen the vertical and/or horizontal locks (Pg 14, Fig. 5, 10 and 18) to permit the optical tube to be freely moved manually. Tighten the locks once you center on the object.

(B) With the horizontal and vertical locks in their "locked" positions, use the Arrow keys to move the optical tube.

Note: For most astronomical observing requirements, approximate settings of the telescope's latitude and North-pointing tripod leg (Steps #5 and #6) are acceptable. Do not allow undue attention to precise

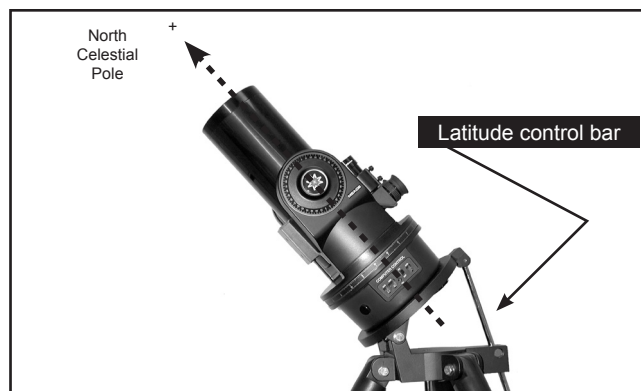

Figure 29: Example of Polar Alignment. Note that the face of the tilt-plate points north

equatorial mounting of the telescope to interfere with your enjoyment of the instrument.

Using an Equatorially Mounted Telescope

Once your telescope is equatorially mounted, the telescope motor drive will keep a celestial object in the telescope eyepiece's field of view.

Caution: Do not move the tripod or adjust the latitude setting while observing or the mounting alignment will be lost. The telescope's motor drive disengages when the Horizontal and the Vertical lock levers are unlocked and re-engages when the levers are relocked.

AudioStar Polar Alignment

AudioStar provides three different (manual) methods for polar alignment: Easy, One-Star and Two-Star.

Easy Polar Alignment

Two alignment stars are chosen by AudioStar based on the date, time and location. First, choose "Polar" from the "Setup: Telescope: Mount" menu. The rest of the procedure is identical to the Alt/Az Easy (Two-Star) Align, page 11.

One-Star Polar Alignment

Polar One-Star Alignment requires some knowledge of the night sky. AudioStar provides a database of bright stars and one star from this database is chosen by the observer for alignment. Polaris is chosen by AudioStar. First, choose "Polar" from the "Setup: Telescope: Mount" menu. The rest of the procedure is almost identical to the Alt/Az One Star Alt/Az Alignment, page 43, except that AudioStar prompts you to point the telescope at Polaris and center it in the telescope eyepiece.

Two-Star Polar Alignment

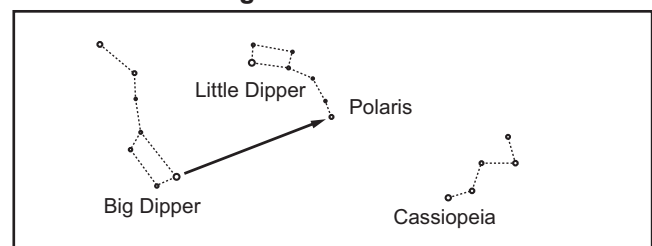

Figure 30: Locating Polaris

Polar Two-Star Alignment requires some knowledge of the night sky. AudioStar provides a database of bright stars and two stars from this database are chosen by the observer for alignment. First, choose “Polar” from the “Setup: Telescope: Mount” menu. The rest of the procedure is almost identical to the Alt/Az Two Star Alt/Az Alignment, page 42.

Locating the Celestial Pole

To get basic bearings at an observing location, take note of where the Sun rises (East) and sets (West) each day. After the site is dark, face North by pointing your left shoulder toward where the Sun sets. To precisely point at the pole, find the North Star (Polaris)

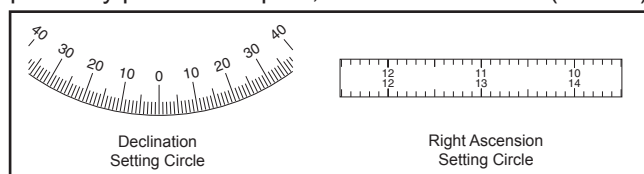

Figure 31: Setting Circles - Dec. and R.A.

by using the Big Dipper as a guide (Fig. 30).

Important Note: For almost all astronomical observing requirements, approximate settings of the telescope’s latitude and Polar axis are acceptable. Do not allow undue attention to precise Polar Alignment of the telescope to interfere with your basic enjoyment of the instrument.

Setting Circles

The ETX models are equipped with R.A. and Dec. setting circles (Pg 15, #13 and #20) to aid in locating faint celestial objects when the telescope has been polar aligned. Setting circles emulate the celestial coordinates found on star charts or in sky catalogs. Any charted object is easily located by coordinates in R.A. (in hours, minutes and seconds, from 0h 0m 0s to 23h 59m 59s) and Dec. (in degrees from 0° to ±90°).

With an ETX model polar aligned, use the Arrow keys to move the telescope in R.A. (left and right keys) and Dec. (up and down keys).

Note: The Dec. setting circle is located on the left arm of the telescope fork mount. The right arm of the mount contains a graduated circle (mounted behind the knurled knob of the vertical lock), without Dec. numbers.

• **Declination Setting Circle:** The Dec. setting circle (Fig. 31) has been factory set to read the correct Declination of celestial objects.

Because the smooth knob on this fork mount arm need never be loosened, the Dec. setting circle should always remain calibrated. If for some reason this knob becomes loose and the Dec. setting circle must be recalibrated, level the optical tube so that it is parallel to the drive base. Loosen the smooth knob covering the Dec. setting circle until the setting circle moves freely. Reposition the setting circle so that the 0 setting aligns with the Dec. pointer (the molded triangle beneath the setting circle). Re-tighten the Dec. knob.

• **Right Ascension Setting Circle:** Since celestial objects move in R.A., the R.A. setting circle (Fig. 31) must be reset as each object is located during an observing session. The R.A. pointer is located on the drive base.

To use the setting circles to find astronomical objects, the ETX must first be polar aligned. It is advisable that the motor drive be turned on and that a low-power eyepiece (e.g., a 26mm eyepiece) be employed. Then use the following procedure:

1. Identify the celestial coordinates (R.A. and Dec.) of a bright, easy-to-find object, such as a bright star. (Avoid using Polaris or any object near Polaris.) Coordinates of bright stars are listed in astronomy magazines, text books or star charts. Center this object in the telescope’s field of view.

2. Manually turn the R.A. circle to read the R.A. of the object at the R.A. pointer (the molded triangle beneath this setting circle).

3. The R.A. circle is now calibrated to read the correct R.A. of any object at which the telescope is pointed. The Dec. circle is already calibrated through polar alignment.

4. To find another object, again identify the R.A. and Dec. coordinates. Then, without touching the setting circles, move the telescope (manually, by unlocking the vertical and horizontal locks or by slewing the telescope using the Arrow keys) so that the R.A. and Dec. pointers read the coordinates of the second object.

5. If the above procedure has been followed carefully, the second object will now be in the telescope's field of view.

Note: Since the second object (i.e., the object to be located) is in constant motion, once the R.A. circle is calibrated (step 2, above) the telescope should be moved rapidly to read the coordinates of the second object. Otherwise the second object will no longer be in the position indicated by the R.A. circle.

Using setting circles requires a developed technique. When using the circles for the first time, try hopping from one bright star (the calibration star) to another bright star of known coordinates. Practice moving the telescope from one easy-to-find object to another. In this way the precision required for accurate object location becomes familiar.

APPENDIX E:

LATITUDE CHART

Latitude Chart for Major Cities of the World

To aid in the polar alignment procedure (see page 55), latitudes of major cities around the world are listed below. To determine the latitude of an observing site not listed on the chart, locate the city closest to your site. Then follow the procedure below:

Northern hemisphere observers (N): If the site is over 70 miles (110 km) North of the listed city, add one degree for every 70 miles. If the site is over 70 miles South of the listed city, subtract one degree per 70 miles.

Southern Hemisphere observers (S): If the site is over 70 miles (110 km) North of the listed city, subtract one degree for every 70 miles. If the site is over 70 miles South of the listed city, add one degree per 70 miles.

NORTH AMERICA			EUROPE (continued)		
City	State/Prov./Country	Latitude	City	Country	Latitude
Albuquerque	New Mexico	35° N	Oslo	Norway	60° N
Anchorage	Alaska	61° N	Paris	France	49° N
Atlanta	Georgia	34° N	Rome	Italy	42° N
Boston	Massachusetts	42° N	Stockholm	Sweden	59° N
Calgary	Alberta	51° N	Vienna	Austria	48° N
Chicago	Illinois	42° N	Warsaw	Poland	52° N
Cleveland	Ohio	41° N	SOUTH AMERICA		
Dallas	Texas	33° N	City	Country	Latitude
Denver	Colorado	40° N	Bogotá	Colombia	4° N
Detroit	Michigan	42° N	São Paulo	Brazil	23° S
Honolulu	Hawaii	21° N	Buenos Aires	Argentina	35° S
Jackson	Mississippi	32° N	Montevideo	Uruguay	35° S
Kansas City	Missouri	39° N	Santiago	Chile	34° S
Kenosha	Wisconsin	45° N	Caracas	Venezuela	10° N
Las Vegas	Nevada	36° N	ASIA		
Little Rock	Arkansas	35° N	City	Country	Latitude
Los Angeles	California	34° N	Beijing	China	40° N
Mexico City	Mexico	19° N	Hong Kong	China	23° N
Miami	Florida	26° N	Seoul	South Korea	37° N
Minneapolis	Minnesota	45° N	Taipei	Taiwan	25° N
Nashville	Tennessee	36° N	Tokyo	Japan	36° N
New Orleans	Louisiana	30° N	Sapporo	Japan	43° N
New York	New York	41° N	Bombay	India	19° N
Oklahoma City	Oklahoma	35° N	Calcutta	India	22° N
Ottawa	Ontario	45° N	Hanoi	Vietnam	21° N
Philadelphia	Pennsylvania	40° N	Jedda	Saudi Arabia	21° N
Phoenix	Arizona	33° N	AFRICA		
Portland	Oregon	46° N	City	Country	Latitude
Salt Lake City	Utah	41° N	Cairo	Egypt	30° N
San Antonio	Texas	29° N	Cape Town	South Africa	34° S
San Diego	California	33° N	Rabat	Morocco	34° N
San Francisco	California	38° N	Tunis	Tunisia	37° N
Seattle	Washington	47° N	Windhoek	Namibia	23° S
Washington	District of Columbia	39° N	AUSTRALIA AND OCEANIA		
EUROPE			City	State/Country	Latitude
City	Country	Latitude	Adelaide	South Australia	35° S
Amsterdam	Netherlands	52° N	Brisbane	Queensland	27° S
Athens	Greece	38° N	Canberra	New South Wales	35° S
Bern	Switzerland	47° N	Alice Springs	Northern Territory	24° S
Copenhagen	Denmark	56° N	Hobart	Tasmania	43° S
Dublin	Ireland	53° N	Perth	Western Australia	32° S
Frankfurt	Germany	50° N	Sydney	New South Wales	34° S
Glasgow	Scotland	56° N	Melbourne	Victoria	38° S
Helsinki	Finland	60° N	Auckland	New Zealand	37° S
Lisbon	Portugal	39° N			
London	England	51° N			
Madrid	Spain	40° N			

APPENDIX F:

REFRACTOR OPTICAL SYSTEM (ETX 80)

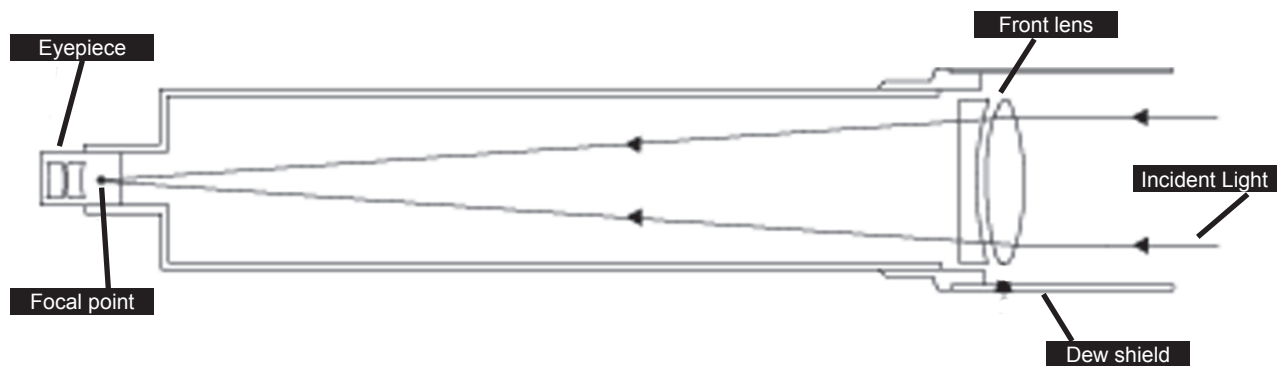

Refracting Telescopes use a large objective lens as their primary light-collecting element. Meade ETX refractors include an achromatic (2-element) objective lenses in order to reduce, or virtually eliminate, the false color (chromatic aberration) that results in the telescopic image when light passes through a lens.

MAKSUTOV-CASSEGRAIN OPTICAL SYSTEM (ETX 90 & 125)

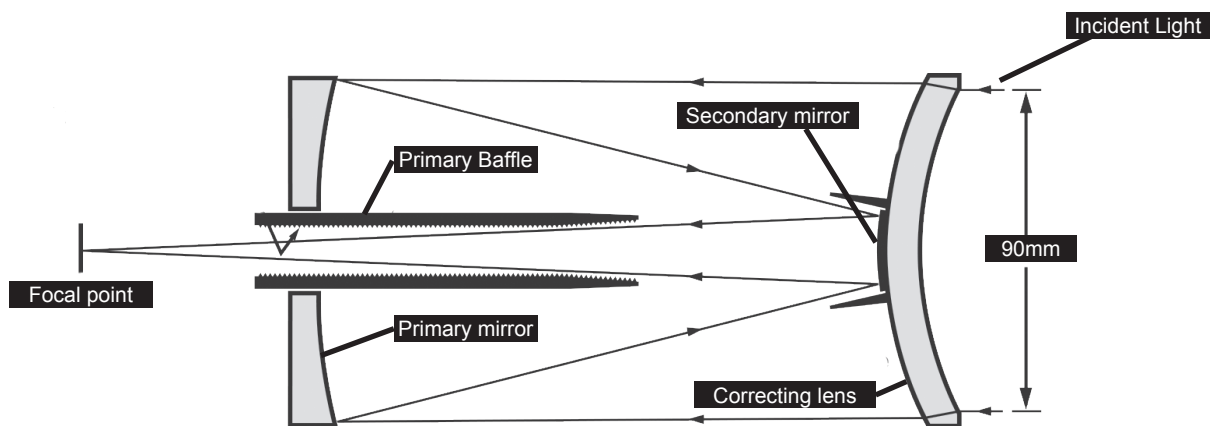

In the optical design of the ETX 90/125, light enters from the right through a multi-coated meniscus lens, proceeds to an $f/2.2$ primary mirror, and then to a convex secondary mirror that multiplies effective focal length by a factor of 6.3. The secondary mirror light baffle, in combination with the anti-reflection threads inside the primary mirror baffle, produces extremely high contrast astronomical images at the focal plane.

RECYCLING INFORMATION

(EU Countries only)



Correct Disposal of this Product

(Waste Electrical & Electronic Equipment)

This marking shown on the product or its literature indicates that it must not be disposed of in unsorted municipal waste at the end of its working life

To prevent possible harm to the environment or human health from uncontrolled waste disposal, please separate this from other types of wastes and recycle it as required by law. Household users should contact either the retailer where they purchased this product, or their local government office, for details of where and how they can take this item for environmentally safe recycling. Business

users should contact their supplier and check the terms and conditions of the purchase contract

This product should not be mixed with other commercial wastes for disposal.

MEADE LIMITED WARRANTY

Every Meade telescope, spotting scope, and telescope accessory is warranted by Meade Instruments Corp. ("Meade") to be free of defects in materials and workmanship for a period of ONE YEAR from the date of original purchase in the USA and Canada. Meade will repair or replace a product, or part thereof, found by Meade to be defective, provided the defective part is returned to Meade, freight-prepaid, with proof of purchase. This warranty applies to the original purchaser only and is non-transferable. Meade products purchased outside North America are not included in this warranty, but are covered under separate warranties issued by Meade international distributors.

RGA Number Required: Prior to the return of any product or part, a Return Goods Authorization (RGA) number must be obtained from Meade by writing, or calling (800) 626-3233. Each returned part or product must include a written statement detailing the nature of the claimed defect, as well as the owner's name, address, and phone number.

This warranty is not valid in cases where the product has been abused or mishandled, where unauthorized repairs have been attempted or performed, or where depreciation of the product is due to normal wear-and-tear. Meade specifically disclaims special, indirect, or consequential damages or lost profit which may result from a breach of this warranty. Any implied warranties which cannot be disclaimed are hereby limited to a term of one year from the date of original retail purchase.

This warranty gives you specific rights. You may have other rights which vary from state to state.

Meade reserves the right to change product specifications or to discontinue products without notice.

MEADE CUSTOMER SERVICE

Have a question concerning your telescope? Call Meade Instruments Customer Service Department! We're happy to help

Before returning the telescope to the factory, call the Meade Customer Service Department first as most problems can be solved over the phone. Make sure to give a full description of the problem, as well as your name, address, and daytime telephone number. The great majority of servicing issues can be resolved by telephone, avoiding return of the telescope to the factory.

If you purchased your telescope outside of the USA or Canada, contact your closest Meade Authorized Dealer or distributor.

CONTACT US

By Phone:

800-626-3233

M-F; 7am - 4pm PST

Via email:

customerservice@meade.com



We appreciate your business. Keep in touch!

Let's Get Social:



@MeadeInstruments



@MeadeInstruments



@MeadeInstrument

Share your photos with us:

#MeadePhotos
Social@meade.com

For special offers and other products, visit our website:

[www. meade.com](http://www.meade.com)

1-800-626-3233

Meade Instruments

27 Hubble

Irvine, CA 92618