



MEADE[®]
INSTRUMENTS

Instruction Manual

**LX850™ German Equatorial Mount Telescope System
With StarLock™**





WARNING!

Never use a Meade® LX850 Telescope to look at the Sun!

Looking at or near the Sun will cause instant and irreversible damage to your eye. Eye damage is often painless, so there is no warning to the observer that damage has occurred until it is too late. Do not point the telescope at or near the Sun. Do not look through the telescope or Finder Scope as it is moving. Children should always have adult supervision while observing.

Travel Screw:

The LX850 f/8 ACF optical tube assembly (OTA) is shipped from the factory with the focusing mechanism protected by a travel screw. This screw secures the primary mirror in a fixed position during travel thereby protecting the focusing mechanism from shock damage. This screw is on the back cell of the OTA, near the Crayford Focuser, and is identified by a dab of red paint.

This screw must be removed before attempting to focus the OTA. Failure in removal can result in damage to the Crayford Focusing mechanism. Retain this screw for future use as it is suggested that mirror be locked down anytime the OTA is shipped.

Move the primary mirror to the travel position by rotating the focuser knob counter clockwise until its travel limit is reached. Reattach the travel screw and tighten until firm. Do not over tighten.

CONTENTS

Introduction

The LX850 Telescope	5
-------------------------------	---

Telescope Features

Precision Machined German Equatorial Mount	6
Faster, Sharper Optical System	6
StarLock — Full-Time Automatic Guiding	6

Key Features

Figure 1: Right View	7
Figure 2: Left View	8
Figure 3: Detail RA Access	9
Figure 4: Detail StarLock Counterweight	9
Figure 5: Detail Saddle Plate	9
Figure 6a: Telescope Control Panel	10
Figure 6b: StarLock Control Panel	10
LX850 Key Features	11

Assembly

Assembly Tools	13
Tripod Assembly	13
Attach Mount Assembly to Tripod	14
Attach Counterweight Shaft	15
Attach Counterweights	15
Routing Connector Cables	15
Removing the Saddle	16
StarLock Cable	16
Attach the Control Module	17
DEC and RA Connecting Cables	17
Attach the Optical Tube Assembly (OTA)	17
Attach Diagonal and Eyepiece	18
Attach StarLock Assembly	18
Plug in the AutoStar II Handbox	19
Attach the Viewfinder to the OTA	19
Mount Additional Accessories and Equipment	19
Balancing the Telescope	19
Balancing the RA Axes	20
Balancing the DEC Axes	20
Balancing StarLock	20

Getting Started

Focusing & Aligning the Viewfinder	21
Focusing the Telescope	21
Slew Speeds	22
Aligning for the First Time	22
Finding True North/alignment on Polaris	22
One Star Alignment	23
Syncing Your Eyepiece/Camera Using Starlock	23
Test your Collimation	24
Collimation of the Optical System: ACF Models	24

® The name “Meade,” “AutoStar” and the Meade logo are trademarks registered with the U.S. Patent and Trademark Office and in principal countries throughout the world.

StarLock, Deep Sky Imager”, “LX850”, and “Tonight’s Best” are trademarks of Meade Instruments Corp.

Protected by U.S. Patent:

US 6,392,799 and other Patents Pending

© 2013 Meade Instruments Corp.

Calibrate Home	25
StarLock Operation	25
StarLock Automatic Rate Calibration (ARC)	26
StarLock and Mount Flexure	26

AutoStar II Operation

The AutoStar II Handbox	27
AutoStar Navigation Exercise	28
Example of Locating a Menu	28
AutoStar II Menu Tree	29
Navigating AutoStar II	30
Object Menu	30
Event Menu	31
Glossary Menu	31
Utilities Menu	32
Setup Menu	33
“Hot Button” Menu	35
StarLock Periodic Error Correction	36

Advanced Autostar II Features

Adding Observing Sites	37
Creating User Objects	37
Using AutoStar to Find Objects not in Database	38
To GO TO a user-entered object	39
Landmarks	39
Identify	40
Browse	41

Alternate Polar Alignments

Two-Star Polar Alignment	42
Easy Polar Alignment	42
One-Star Polar Alignment	42
Align on Home	42
How to Drift Align LX850	42
Download the Latest Version of AutoStar II Software	43
StarLock Assisted PEC Training	43
Update Menu Option	43
Erase Menu Option	43
On and Off Menu Options	43

Optional Accessories 44

Maintenance 46

Customer Service 46

Specifications 47

Appendix A: Manual Drift Alignment 49

Appendix B: StarLock Utility 50

Appendix C: Automatic Rate Calibration (ARC) 53

Appendix D: Latitude Chart 54

Appendix E: Advanced Coma-Free Optical System 55

Appendix F: Initial Set-up Guide 56

Recycling: How to recycle 58

Meade Warranty One Year Limited Warranty Back Cover

INTRODUCTION

The LX850 Telescope

Advanced Technology for the Astro Imager

Congratulations on receiving your new **LX850** telescope. You'll find that this telescope system has all you need to explore the Universe we live in. Designed from the ground up to be the ideal Astro-imaging platform, the LX850 incorporates several new revolutionary technologies that will change the way you observe and image. Available only from Meade.

Drawing on over 40 years of experience and innovation, Meade Instruments introduces the latest in a long line of advanced astronomical products: the LX850. Using revolutionary new technology, every aspect of this amazing telescope system has been designed to deliver the new standard in astrophotographic and visual performance:

- Fast f/8 Advanced Coma-Free (ACF) optical systems on the 10", 12" and 14" OTAs. These optics produce wider, flatter fields with no coma for pinpoint stars out to the edge of larger imaging sensors or extreme wide angle eyepieces.
- 130mm 3-element, air-spaced apochromatic f/7 refractor with 3" Crayford-style 10:1 focuser. Beautifully machined and finished with case. Optional 3" field flattener available.
- StarLock™ full-time automatic integrated guider assists with drift polar alignment, finds and centers targets and then automatically locks onto a field star as faint as 11th magnitude for one arcsecond guiding. No separate computer, no guide star selection, no user focus. Just set up your camera and image (patent pending).
- German Equatorial Mount made from machined aluminum and stainless steel with large bearing surfaces and roller bearings in both axes for an extremely solid and stable platform.
- Internal Crayford-style primary mirror focusing system with a dual speed 7:1 focus control, on ACF OTA's, eliminates image shift and mirror flop. Precise focus is a snap (patent pending)

If you are like us, you can't wait to get outside under a dark sky to use your new **LX850** telescope. We have provided a Getting Started Guide that will get you up and running in the shortest amount of time possible. After your first experience, please sit down with this manual and read about all the advanced features that are available to you with this telescope system. We are confident that the **LX850** will keep you fascinated with the Universe and entertained for many years to come.

Clear Skies,

The people at Meade



Telescope Features

Meade Instruments introduces the latest in a long line of advanced astronomical products: the LX850™. Using revolutionary new technology, every aspect of this system has been designed to deliver the new standard in astrophotographic and visual performance.

Precision Machined German Equatorial Mount



Constructed of machined stainless steel and aircraft grade 6061-T6 aluminum, the LX850 mount presents a rock-solid platform with precision roller bearings on both axes and a 1.75 inch stainless steel RA shaft. Its .68 inch diameter brass worms and 5.8 inch diameter, 225-tooth aluminum gears deliver smooth, precise movement with up to a 90 pound instrument load. Add to this internal cabling, GPS and the AutoStar II fully-computerized GoTo system with a database of over 144,000 objects. All this sets atop a new ultra-stable tripod.

Faster, Sharper Optical System



Building on Meade's award-winning Advanced Coma-Free™ (ACF™) optics, the LX850 employs a fast f/8 optical system with high-contrast baffling that assures crisp, pinpoint imaging to the very edge of the field. The all-new OTAs feature an internal Crayford-style,

zero image-shift focusing system with a two-speed, 7:1 control that rigidly holds the primary mirror (patent pending). In addition, with the LX850's optional large-format, three-element f/5 focal reducer/field flattener, you gain even wider fields, faster exposures and a flat field even on larger sensors (available soon). Also available is Meade's new Series 6000 3 element air-spaced f/7 apochromatic refractor. This finely machined and finished OTA features superior optical performance, a 3" Crayford-style 10:1 focuser and an optional 3" field flattener.

StarLock™ — Full-Time



Automatic Guiding

StarLock — the heart of the LX850 — is the revolutionary new technology that makes target acquisition on your imaging sensor and accurate guiding during exposures completely automatic. With Meade's exclusive LightSwitch™ technology at its core, StarLock uses a 80mm f/5 optic and a super wide-angle lens in a two camera system that automatically finds your target in high-precision, immediately captures a field star as dim as 11th magnitude and then guides to an incredible accuracy of one arcsecond. StarLock achieves this amazing accuracy because, unlike add-on guiders, StarLock is integrated into the telescope control system and communicates directly with the motor controllers in real time with a maximum precision of 0.1 arcseconds. There's no need for a separate guider or computer and StarLock requires no calibration, no user focusing or guide star selection. StarLock also provides computer-assisted polar alignment using the drift method for extreme precision. No expensive shaft encoders or add-on guiding systems can provide this level of performance (patent pending).

LX850 Key Features



- | | | |
|---------------------------------------|--------------------------------------|--------------------------------|
| 1 Viewfinder | 15 Counterweight | 31 StarLock Dovetail Locks |
| 3 HD-60 25mm Eyepiece | 16 Azimuth Lock Bolts | 34 Azimuth Adjustment Knob |
| 4a Rear Cell Port | 17 Altitude Adjustment Knob | 36 StarLock Counterweight |
| 4b SC Thread to 2" ACC Adapter | 19 RA Clutch Lock Bolts (3) | 37 StarLock Counterweight lock |
| 5 Diagonal Mirror Thumbscrews | 20a RA Drive | 38 GPS Sensor |
| 6 2" Star Diagonal with 1.25" Adapter | 20b RA Drive Connector | |
| 7 2-Speed Focus Knob | 22 DEC Drive | |
| 8 AutoStar II Handbox | 24a StarLock Narrowfield OTA | |
| 9 Handbox Holder | 24b StarLock Widefield OTA | |
| 10 Handbox Holder Tension Knob | 25a StarLock Imaging Sensor Assembly | |
| 11 AutoStar II Coil Cord | 25b StarLock Cable | |
| 12 Telescope Control Panel | 28b StarLock Mount (On OTA) | |
| 13 Counterweight Safety Cap | 29 OTA Dovetail Lock | |
| 14 Counterweight Shaft | 30 Altitude Scale | |

Figure 1: LX850 Key Features - Right View

LX850 Key Features

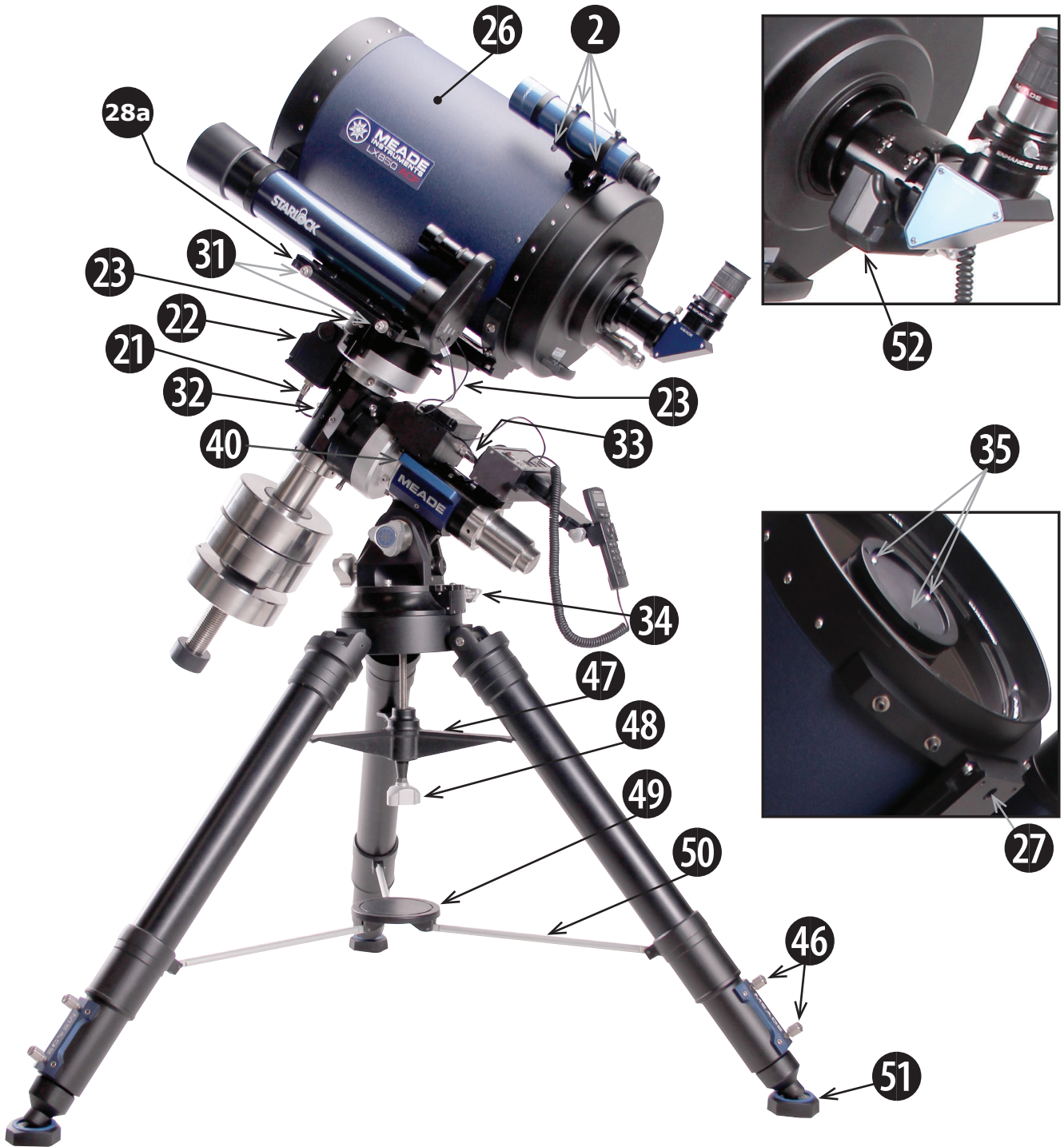

- | | | |
|-----------------------------------|----------------------------------|----------------------------------|
| 2 Viewfinder Collimation Screws | 33 RA External Cable Access Port | 49 Tension Hub |
| 21 DEC Drive Power Connector | 34 Azimuth Adjustment Knob | 50 Extension Arms |
| 26 Optical Tube Assembly (OTA) | 35 Collimation Screws (3) | 51 Anti-Vibration Pads |
| 27 Dovetail Plate Safety Bolt | 40 Carry Handles | 52 Zero Image Shift Microfocuser |
| 28a StarLock Mount (on saddle) | 46 Leg Locks | |
| 31 StarLock Dovetail Lock Bolts | 47 Spreader Bar | |
| 32 DEC External Cable Access Port | 48 Tension Knob | |

Figure 2: LX850 Key Features - Left View

LX850 Key Features

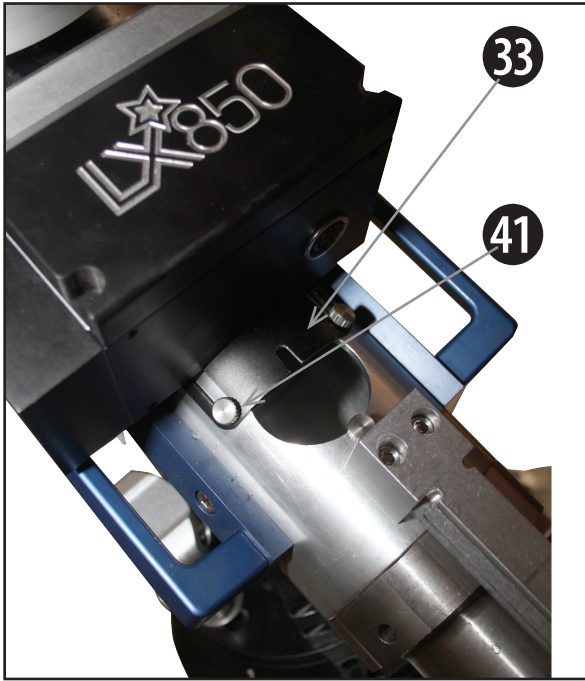

Figure 3: Detail, RA Access

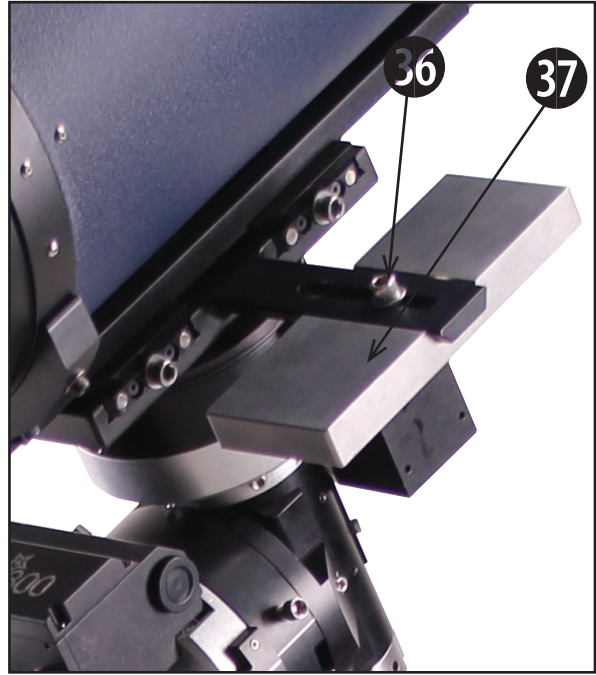
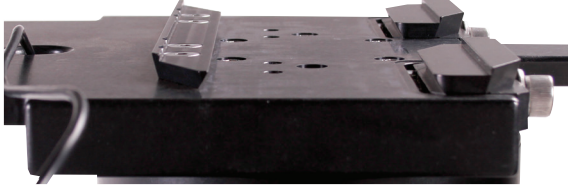



Figure 4: StarLock Counterweight

39 **Mount Saddle Plate Configurations**



Losmandy® Style Dovetail Configuration





Vixen® Style Dovetail Configuration

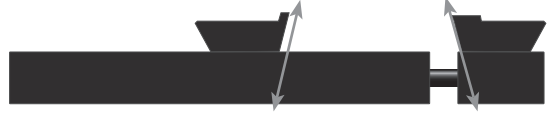

Note that there are different angled surfaces on the dovetail brackets on the saddle. In addition to physically moving the dovetail to accommodate the differing width of Losmandy or Vixen it is important to orient the bracket so that the pitch to the dovetail matches the corresponding mount. Note that Losmandy style mounting configuration utilizes the larger, more pronounced pitch. See above

Figure 5: Saddle Plate

- 33 RA Internal Cable Access Port
- 36 StarLock Counterweight
- 37 StarLock Counterweight Lock Bolt
- 41 Lock-down set screw for cover

LX850 Key Features



Figure 6a: Telescope Control Panel

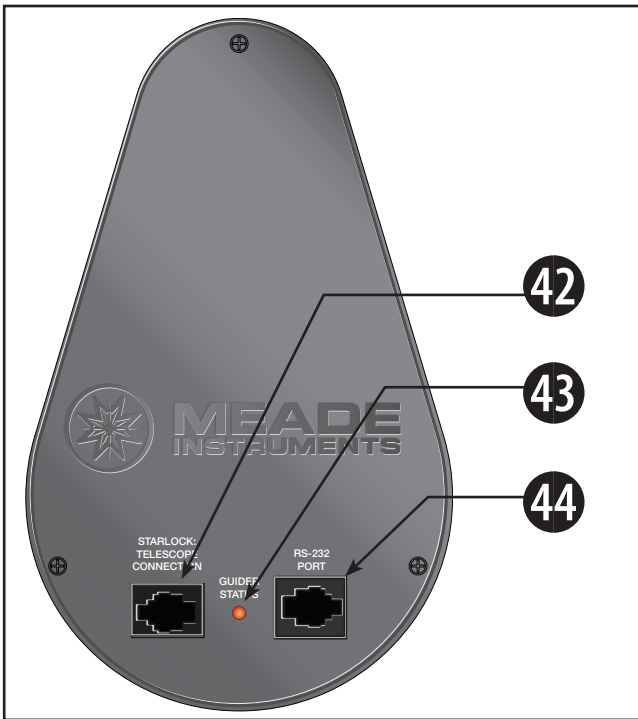

Figure 6b: StarLock Control Panel



Figure 6c: OTA Rear View

Telescope Control Panel:

- A. ON/OFF Switch
- B. 12v DC Power Connector
- C. Electronic Focus Port
- D. Illuminated Reticle Eyepiece Power Port
- E. 12v DC Output
- F. Handbox (HBX) Port
- G. RS232 Port

- H. StarLock Port
- I. Aux Autoguider Port

- 42 StarLock Telescope Connection
- 43 Guider Status
- 44 RS-232 Port
- 45 Travel Screw

Figure 2-B: LX850 Key Features - Telescope Control Panel

LX850 Key Features

- 1 Viewfinder: 8x50, wide-field sighting scope with crosshairs that enables easy centering of objects in the telescope eyepiece.
- 2 Viewfinder Collimation Screws: Adjust these screws to align the viewfinder. See page 23 for more information.
- 3 Eyepiece: Place the supplied HD-60 25mm eyepiece into the 2" Star Diagonal with 1.25" Adapter (**Pg 18, Fig. 24**) and tighten in place with locking thumbscrew.
- 4 SC Thread to 2" accessory adapter: The 2" Diagonal Mirror is inserted into this adapter.
- 5 2" Adapter Thumbscrews: Tighten to secure the 2" Diagonal in place.
- 6 2" Star Diagonal with 1.25" Adapter: Holds the eyepiece upright for easy viewing. Provides a more comfortable right-angle viewing position. Slide the diagonal directly into the 2" Adapter and tighten the thumbscrew to a firm feel only. See page 18 for a photo and more information.
- 7 2-Speed Crayford Style Focusing Knobs: Moves the telescope's primary mirror in a finely-controlled motion to achieve precise image focus. The LX850 telescopes can be focused on objects from a distance of about 200 ft to infinity. Rotate the focus knob clockwise to focus on distant object.
- 8 AutoStar II Handbox: The LX850 user interface. Use the Handbox to command the LX850 to automatically slew to any object in the night sky. See pages 27 thru 36 for a description of features.
- 9 Handbox Holder: convenient place to place your AutoStar II box. Keeps it at the ready.
- 10 Handbox Holder Tension Knob: Loosen to adjust presentation angle – tighten to lock in place.
- 11 AutoStar II Coil Cord: Connects the handbox to the Computer Control Panel via the HBX port.
- 12 Telescope Control Panel:
 - A. ON/OFF Switch
 - B. 12v DC Power Connector
 - C. Electronic Focus Port
 - D. Illuminated Reticle Port
 - E. 12v DC Output
 - F. Handbox (HBX) Port
 - G. RS232 Port
 - H. StarLock Port
 - I. Aux Autoguider Port
- 13 Counterweight Safety Cap: Prevents the counterweight from accidentally slipping off the end of the counterweight shaft.
- 14 Counterweight Shaft: Thread the counterweight onto this shaft (below).
- 15 Counterweight: Counterbalances the weight of the optical tube, and adds stability to the mount.
- 16 Azimuth Lock Bolts. Once your LX850 is aligned on the celestial pole, lock the azimuth bolts to prevent movement in this direction.
- 17 Latitude Adjustment Knob. Used to set the LX850 to the correct Latitude for your observing site.
- 18 Latitude Lock Knob. Before using the Latitude Adjustment Knob, loosen the Latitude Lock Knob. Once the Latitude is adjusted, be sure to lock this knob to prevent unwanted movement of the LX850.
- 19 RA Clutch: Tighten the three hex head screws using the included 5/16" hex head tool to engage the RA Drive.
- 20a. RA Drive: Precisely moves the telescope around the RA Axis.
- 20b. RA Drive Cable: Connect the RA drive to the Telescope Control Panel.
- 21 DEC Drive Cable: Connects the DEC Motor to the Compute Control Panel.
- 22 DEC Drive Housing: Precisely moves the telescope around the DEC Axis.
- 23 DEC Clutch: Tighten the three hex head bolts using the included 5/16" hex head tool to engage the DEC Drive.
- 24a StarLock Narrow Field OTA: Narrow field optics that are used to precisely guide LX850

LX850 Key Features

StarLock System.

- 24b** StarLock Widefield OTA: Used to orient the LX850 in relation to the sky.
- 25a** StarLock Connector Panel: Starlock cable connection point and place where Starlock status is displayed.
- 25b** StarLock Connector Cable: 4-pin connector cable plugs into StarLock.
- 26** Optical Tube Assembly (OTA): The main optical component that gathers the light from distant objects and brings this light to a focus for examination with the eyepiece.
- 27** Dovetail Rail Safety Bolt: Make sure the Safety knob is securely attached.
- 28** StarLock Mount (Left side view): Attaches StarLock to the telescope mount saddleplate.
- 29** OTA Lock: Secures the OTA to the LX850 saddle plate.
- 30** Altitude Scale: Set the latitude of the observing site on this scale using the latitude adjustment knob.
- 31** StarLock Locking Bolt: Secures the StarLock assembly to the saddle plate.
- 32** DEC Internal Cable Access Port: Loosen the two thumbscrews, slide the door open to gain access to the cable raceway that runs the length of the DEC Axis.
- 33** RA Internal Cable Access Port: Loosen the two thumbscrews, slide the door open to gain access to the cable raceway that runs the length of the RA Axis.
- 34** Azimuth Adjustment Knob: Once the Azimuth Locking bolts are loose, make adjustments to the mounts azimuth position aligning it to the celestial pole. When properly adjusted, lock the Azimuth Adjustment Lock bolts to prevent unwanted Azimuth movement in the LX850.
- 35** ACF Collimation Adjustment Screws: Use these 3 screws to fine tune your OTA's optical alignment.
- 36** StarLock Counterweight: Precisely counter balance the StarLock assembly by moving this weight. Remove if you mount StarLock directly on the OTA.
- 37** StarLock Counterweight Lock: Tighten to secure the counterweight in place.
- 38** GPS Sensor: Used to get precise date, time and location of your observing site using global positioning satellites.
- 39** Dovetail Adapter Attachment Rails: The LX850 dovetail adapter is unique in that it will accept both the Losmandy and Vixen style dovetails. Remove and reverse the two surrounding dovetail rails so the correct rail angle points toward the dovetail size being used. Be sure to securely tighten the rails. See page 9.
- 40** LX850 Carry Handles: Use these carry handles to help move the LX850 mount from one location to another.
- 41** Access Port Knob: Secures cover plates to RA and DEC cable raceway.
- 42** StarLock Telescope Connection: Connect StarLock to the telescope control panel.
- 43** Guider Status: LED indicates operation.
- 44** RS-232 Port: Additional RS-232 port.
- 45** Travel Screw: Firmly secures the primary mirror in a fixed position during travel protecting the focusing mechanism from shock damage. Remove this screw before attempting to focus the telescope.
- 46** Leg Lock: Locks leg extension in place.
- 47** Spreader Bar: Rigidly holds legs open.
- 48** Tension Knob: Tightens spreader bar to legs.
- 49** Tension Hub: Locates extension arms.
- 50** Extension arms: Locates tripod legs.
- 51** Anti-Vibration Pad: reduces vibrations and shortens damp-down time.
- 52** Zero Image Shift Microfocuser for precision, remote focusing.

Assembly

You may want to perform the assembly of the LX850 in the light of day to become familiar with the parts and operation before performing observations on the night sky. Setup the telescope in a large open area where you can see lots of sky. Do not setup right next to a building or a wall that will obstruct its view of the sky. Make sure the ground is stable and is approximately level. It is best to set up the scope away from bright nighttime lighting, as bright lights will spoil your night vision and impede your ability to see the sky.

The LX850 system includes the following:

- German Equatorial Mount Assembly with Dovetail Saddle Plate
- StarLock Optical Tube and Sensor Assembly
- Counterweight(s)
- Counterweight Shaft with Safety Nut
- LX850 Field Tripod
- LX850 Accessories
- LX850 Control Panel
- Autostar II Hand Controller
- StarLock Cable
- StarLock Counterweight
- Custom Utility Tool
- 5/16" Hex head wrench
- DVD with AutoStar Suite and software
- #507 Connecting Cable with USB Adapter
- Internal Cable Fish Tool
- Anti-Vibration Pads
- Micro-focuser (ACF OTAs only)

Additionally, the LX850 can be ordered with various OTAs and Accessories and may contain additional counterweights and boxes depending on the configuration ordered.

Assembly Tools

All of the tools necessary to assemble your LX850 telescope will be found in the accessory box:

- LX850 lock knob wrench: A dedicated tool for securing small and large knobs on both the telescope and tripod.
- 5/16" hex head wrench: Required for securing DEC and RA clutches.



Fig 7: LX850 assembly tools.

- Internal Cable Fish Tool: Assist routing StarLock, DEC, RA and accessory connecting cables

Use of these tools will be described in the assembly procedure. If you will be attaching an OTA that utilizes a Vixen Style dovetail you will need a 3/16" hex head wrench (included) to relocate the mounting rails on the dovetail plate.

Tripod Assembly

Remove the LX850 field tripod from the shipping carton. Included in this carton is the spreader bar, threaded rod (with spacer) and retaining clip; set these aside. Position the tripod where you want the telescope to be assembled. Stand the tripod vertically with the tripod feet down and with the tripod still fully collapsed. Grasp two of the tripod legs and, with the full weight of the tripod on the third leg, gently pull the legs apart to a fully open position. The legs should be spread so the three leg braces are spaced evenly apart and the tripod head is approximately level. Position one of the legs so that it points approximately true South (True North in the southern hemisphere). This will allow the counterweight shaft to clear the tripod if used at low latitudes.



Fig 8: Tripod.

Loosen the two (2) leg lock-knobs on each tripod leg. Adjust the height of the tripod to the desired height and with the tripod head approximately level, tighten the leg locks. Tighten the locks to a firm feel only; do not over tighten.

Slide the threaded rod through the spreader and then slide this assembly through the central mounting hole in the tripod head. Place the threaded rod through central mounting hole far enough so that the retaining clip channel is exposed. Press fit the retaining clip through the machined channel. The retaining clip will now hold the spreader bar for easy assembly.

Attach Mount Assembly to Tripod

Remove the equatorial mount assembly from the shipping carton. You may notice as you are removing the mount that the RA and DEC clutches are not locked. This is intentionally done at the factory to prevent possible damage to the gears while in transit.



Fig 9: Mount in Box

Manually tighten down the three (3) RA and three (3) DEC clutch lock bolts using the supplied 5/16" hex head wrench to facilitate easier handling during

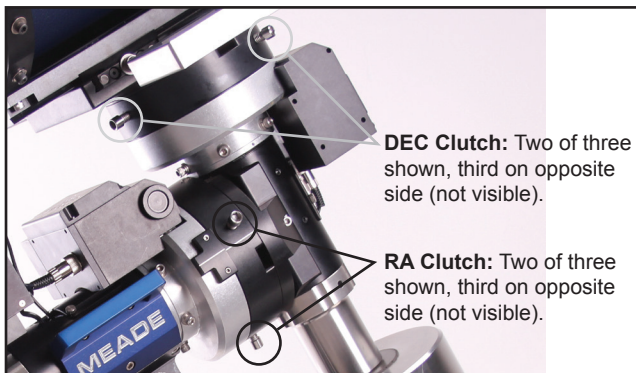

Fig 10: DEC and RA Clutch Locations

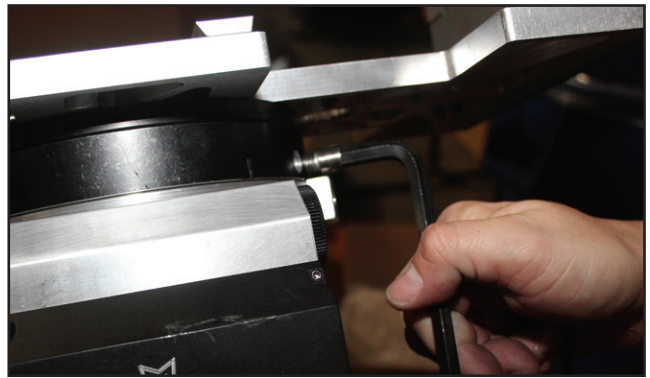

Fig 11: Tighten Clutch.

assembly. **DO NOT OVERTIGHTEN.**

Place the mount on the tripod head. At this point it is advisable to either use one hand, or (ideally) enlist someone else's hand, to steady the mount while it is fastened to the tripod.

Orient the mount so that it aligns with the poles, control panel facing the South pole (North pole in the southern hemisphere). Push the threaded rod up and secure the mount to the tripod by tightening the central lock knob. Use the supplied custom utility tool to secure it to a "tight" fit. If properly secured, the spreader bar will make contact with all three tripod legs and the mount will not slip.

Setting Latitude

Refer to the latitude chart on Appendix D, page 54. Listed are the latitude for most major cities world wide. Locate your city in the chart and note its latitude. If your city is not listed follow the formula to calculate your locations latitude.

Loosen the Attitude Adjustment Lock Knob (fig. 18, page 7). Locate the Attitude Adjustment Knob (fig. 17, page 7) and the Latitude Scale (fig. 30, page 8). The



Fig 12: Attach Counterweight Shaft.

latitude scale has markings and a range that start at zero (0) and ends at 70. Turn the Attitude Adjustment Knob until the indicator points to your corresponding latitude. Tighten the Attitude Adjustment Lock Knob.

Attach the Counterweight Shaft

Remove the counterweight shaft, with attached safety nut, from its packaging. The safety nut is attached at the factory for shipping. Removing the safety nut at this time to lighten the counterweight shaft and make it easier to attach on the DEC axis. Remove the retaining nut by unscrewing it and set aside. Thread the shaft into the receiver, making sure that the threads are matching, not binding or cross threading.

Attach the Counterweight(s)

The counterweights are attached by threading them onto the counterweight shaft to the desired position. If the LX850 mount was purchased with a Meade optical tube assembly (OTA), additional counterweights may have been included depending on the OTA purchased. Attach all counterweights that were included with the mount. A good starting position for the counterweights is to place them in the middle portion of the counterweight



Fig 13: Attach Counterweight.

shaft. When the mount is fully assembled with OTA and accessories, the counterweights will be adjusted to obtain a proper balance with the OTA. Note: 12" and 14" f/8 ACF models please refer to Appendix F for detailed counterweight instructions.

NOTE: WHEN ATTACHING THE COUNTERWEIGHT(S) TAKE CARE NOT TO DROP THEM DURING ASSEMBLY AS THEY CAN CAUSE SERIOUS INJURY, ESPECIALLY ON THE FOOT. WHEN ATTACHING OR ADJUSTING THE POSITION OF TWO (2) Counterweights PAY ATTENTION TO

THE POSITION OF YOUR HANDS SO NOT TO PINCH THEM DURING ADJUSTMENT.

Screw the safety nut on then end of the shaft after the counterweight(s) have been attached.

Routing Connector Cables Internally

Designed into the LX850 mount is a raceway that routes cables through the body of the mount. Cables connecting the RA, DEC motors and StarLock to the control panel can be routed through this raceway, eliminating worrisome "cable interference." The dedicated connecting cable(s) can be found in the StarLock and/or the accessories box along with a assisting cable routing tool. Cables for additional equipment such as cameras can also be routed through the internal raceway. **Note:** the StarLock cable has been installed at the factory. Starlock's 6-pin

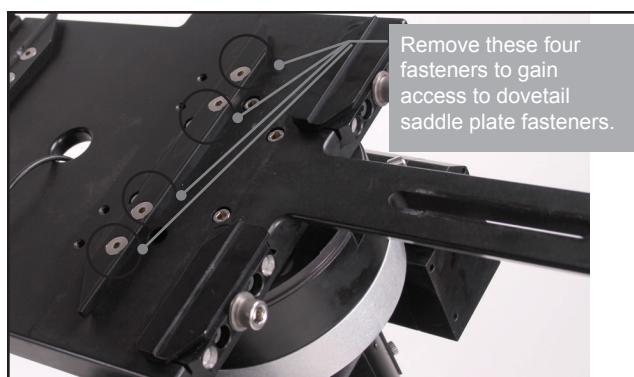

Fig 14: Remove left OTA dove tail mount.

connector connects to the control panel and the 4-pin connector should be threaded through the hole in the saddle plate and connected to the StarLock.

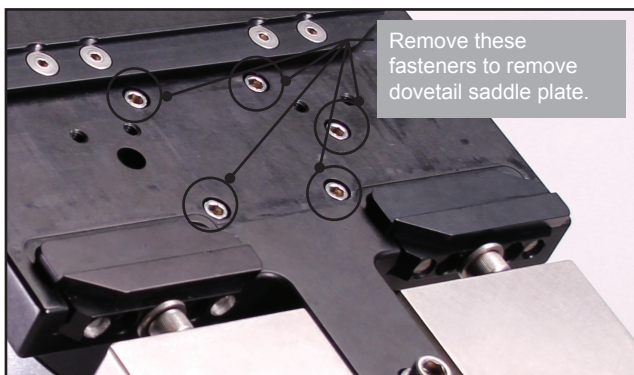

Fig 15: Access to left saddle fastener revealed.

Removing the Saddle

Your telescope mount shipped from the factory with the OTA mount saddle attached. You will have to remove it to gain access to the upper portion of the internal raceway to finish routing any additional cables you want to run to the OTA for cameras or other optional equipment. Remove the StarLock counterweight by loosening its retaining knob and sliding it off. Using a 3/16" hex-head wrench, loosen and remove the five (5) hex nuts that fastens the saddle to the mount. Take care when removing the fifth (5th) and last fastener; making sure to support the weight of the saddle as it becomes free.

With the saddle removed, you are now ready to route the cable(s) through the upper portion of the internal raceway. The StarLock cable comes pre-routed from the factory. If it has been removed or you need to route additional cables from the OTA (eg. Camera cables) follow these instructions.

StarLock Cable:

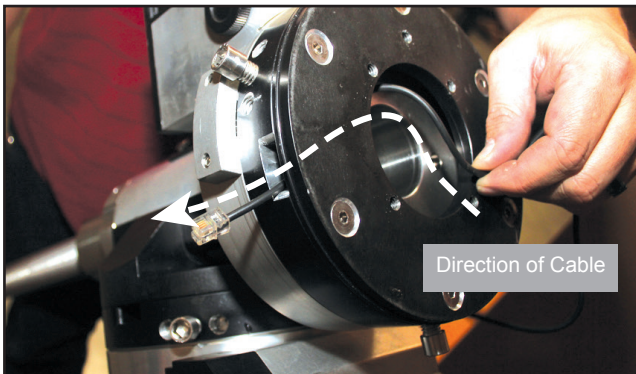

Fig 17: Routing cable under the saddle plate.

Important note: the StarLock cable is directional! Each end has connectors with different configurations; each connector configuration must be correctly oriented

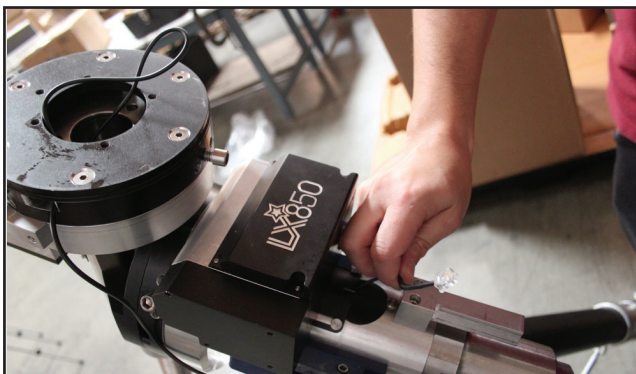

Fig 18: Pulling cable out to connect to control panel.

so that it will plug into its corresponding receptacle. The four-pin connector is inserted into the four-pin receptacle on the back of the StarLock. The six-pin connector is plugged into the six-pin receptacle on the mount control panel labeled "StarLock". Please note the correct cable orientation before beginning to route the cable(s).

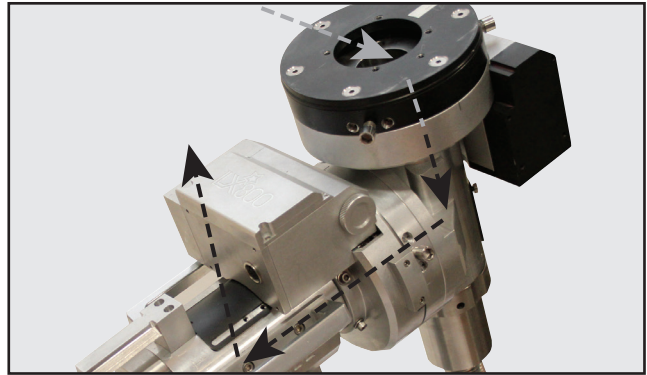

Fig 19: Route of cable from StarLock module

Begin by passing the four-pin connector thru the side passway in the DEC housing below the OTA saddle (**Page 8 and 9, fig 2 and 3**). This four-pin connector will plug-in to the receptacle on the back of StarLock. Pass the cable end with the six-pins down the DEC shaft. Open the access port at the front of the RA axis

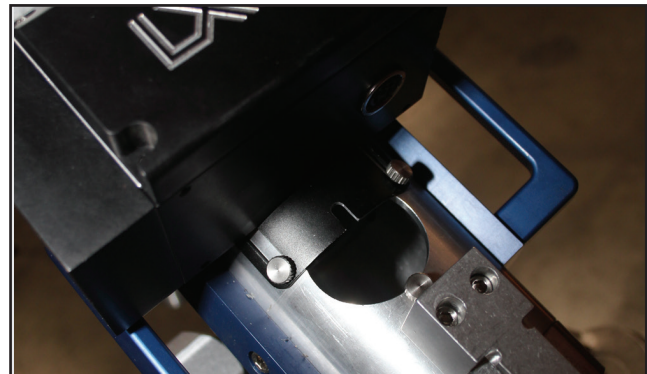

Fig 16: Access to the cable raceway.

and as the six (6) end feeds down grasp and pull it out, taking care not to pull the four-pin connector through the side passway in the DEC housing. Then feed the six-pin end down the RA shaft toward the DEC access door (**Page 8, Fig 32**). Slide open the cable access port door by loosening the two knurled knobs (**Page 9, Fig 41**). Observing through this port, and feeding the six-pin cable through, grasp it as it comes through the port. Again, take up the excess cable. This six-pin

connector is now ready to be inserted into the RS232 receptacle on the control panel labeled “StarLock.”

At this point you will need to reattach the Optical Tube Saddle Plate. Reverse the steps outlined in the step “Removing the Saddle” above.

Attach the Control Module

Take the control panel module out of the box that

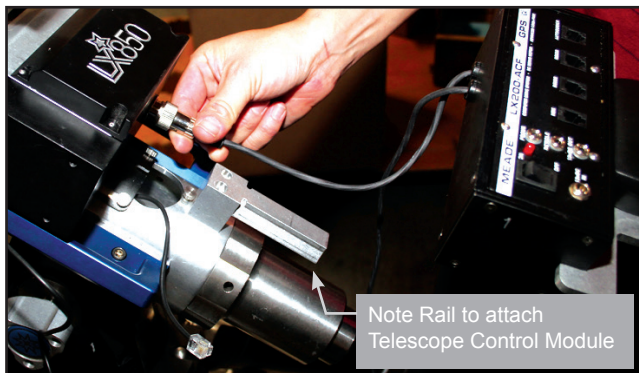

Fig 20: Connecting motor to control module.

contained the mount, and slide it on the mounting rail at the rear end of the RA housing. Loosen the two knurled set-screw knobs on the bottom side of the control module and slide it on the rail, tightening the same set-screw knobs. Insert the StarLock six-pin connector into the receptacle labeled “StarLock” (Page 10, Fig. 6a, H).

DEC and RA Connecting Cables

The connecting cables for the RA & DEC are attached to the control panel module and can not be removed from the module. The short cable connects directly to the RA gearbox that is directly above the module.



Fig 21: DIN Style Connector

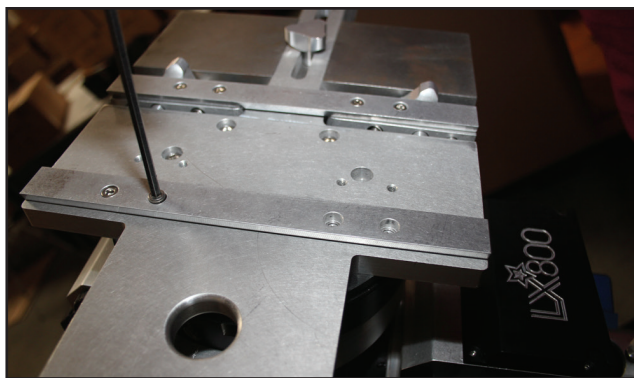

Fig 22: Replace the saddle plate

Insert the DIN connector, observing and aligning the orientation of the pins to match. Once the pins are seated, secure by screwing the dedicated retaining collar until firm (Fig. 21). The longer cable connects to the DEC gearbox and will need to be threaded through the access port on the RA axis, directly above the module (Fig. 20). Using the cable pull tool feed the cable through the raceway, watch for it through the access port on the front of the RA axis (Fig. 21). Grasp it as it comes within reach, and feed through the excess cable. Once it has been fed through, insert and secure the connector to the DEC drive directly above the access port (Page 8, #21). Once the pins are seated, secure by screwing the dedicated retaining collar until firm.

Attach the Optical Tube Assembly (OTA)

Note that there are two options for orientating the dovetail rail and its location. As shipped from the factory, dovetail rails are configured to receive a standard Losmandy®-style dovetail. Meade LX850 OTAs are shipped with their dedicated dovetail plates pre-attached to the tube. Depending on your OTA's



Fig 23: Slide the OTA dovetail into the saddle plate

NOTE: Remove the travel screw before attempting to focus the OTA. Failure to do so may result in damage to the Crayford focusing mechanism.

dovetail, you may need to relocate both sides of the dovetail receiver rails (**Page 9, Fig. 5**).

- **OTAs with a Losmandy®-Style Dovetail:** All Meade LX850, Advanced Coma-Free Optical tubes utilize the standard Losmandy®-style dovetail plate. To prepare the LX850 Dovetail adapter to accept the Losmandy dovetail plate, the mounting rails on the dovetail adapter must be positioned in the correct location and with the correct long side of the rail facing inward toward its corresponding mounting rail. If you look at each long side of the rail, you will notice the draft angle is different on each side (**Page 9, Fig 5**). Make sure the correct angled side is used on both rails before attaching the OTA. Both rails should be secured firmly to the dovetail adapter before an OTA is attached.
- **NOTE:** Due to its weight and size, it is advisable that the 12" & 14" Advanced Coma-Free OTAs be mounted by two (2) people.
- **OTAs with a Vixen®-style dovetail:** All Meade LX850 refractors utilize a standard Vixen®-style dovetail plate. To configure the dovetail adapter to accept this dovetail plate, orient the adapter rails so that the narrow draft angle is facing inward as shown (**Page 9, Fig. 5**). Position the inner rail so that it will mate with the narrowest set of mounting points.

NOTE: Before attaching an OTA to the mount, make sure the clutches on each axis are locked so the mount does not shift during OTA installation and the proper number of counterweights are attached.

The saddle plate is pointing straight up the RA axis with StarLock dovetail mounting position on the left side when viewed from behind the mount.

To attach an OTA, firmly grasp the OTA, remove from the shipping box, and slide the dovetail plate into the dovetail adapter. Maintaining a firm grip on the OTA, tighten the two (2) lock-bolts on the dovetail adapter to a "firm" feel.

Attach Diagonal and Eyepiece

Remove the dust cap from the rear cell of the telescope.

- **Meade Advanced Coma-Free OTAs:** If your telescope was shipped with Meade's #1209 Zero Image Shift Microfocuser please refer to the

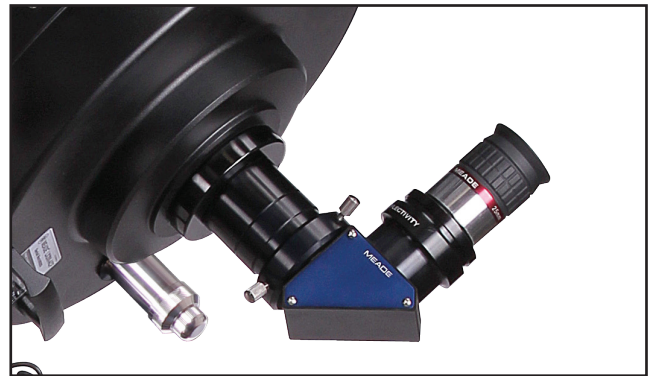

Fig 24: Diagonal and eyepiece in place

detailed instructions that were included.

- **Meade Refractors:** Slide the diagonal mirror into the focuser and lock in place by turning the thumbscrew(s) to a firm feel. Remove the Meade eyepiece from its container and place it in the diagonal mirror. Tighten the thumbscrew(s) to a firm feel only.

Attach StarLock Assembly

StarLock's default mounting location is on the saddle plate. The 10", 12" and 14" ACF models feature a second mounting location at the top-rear of the optical tube assembly. Due to the longer focal length of the ACF optics, this second, top of the OTA mounting point, is preferred for these telescopes, as it minimizes



Fig 25: StarLock mounted on ACF OTA

any differential flexure.

Locate and unpack the StarLock assembly. The dovetail adapter and its dedicated counterweight are pre-installed at the factory and are correctly configured for use in the Northern Hemisphere. For use in the Northern Hemisphere, the StarLock assembly is attached to the dovetail adapter on the left side of the

NOTE: Remove the travel screw before attempting to focus the OTA. Failure to do so may result in damage to the Crayford focusing mechanism.

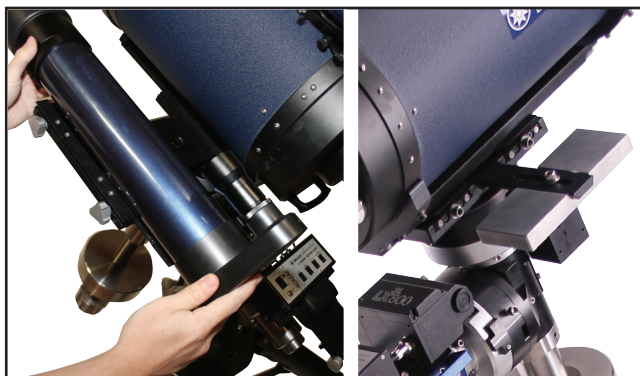

Fig 26: Mounting StarLock to the saddle plate. Attach StarLock counterweight.

OTA. To install StarLock, loosen the two (2) retaining nuts at the side of dovetail adapter, slip in the StarLock assembly, position Starlock so that the back edge of the StarLock dovetail is flush with the lower edge of the saddle plate. Tighten to securely retain StarLock (Page 8, Fig. 42). Locate the included rectangular counterweight, loosen its securing thumbscrew, and slide it on the rail on the opposite side of the dovetail adapter (if needed). **Note that the counterweight is NOT needed when StarLock is mounted to a LX850 ACF OTA.** Use the counterweight when StarLock is mounted directly to the saddle plate. Secure the counterweight by re-tightening the nuts.



Fig 27: Connect handbox cable to HBX

Attach the four-pin StarLock connector cable to the rear panel of StarLock in the receptacle on the left side (Page 10, Fig. 42).

Plug in the AutoStar II Handbox

Locate and unpack the AutoStar II handbox. The connecting cable is packed together with the handbox. Plug one connector into the handbox, and the other into the “HBX” receptacle on the control module.

Attach the Viewfinder to the OTA

The Meade OTAs sold with the LX850 are equipped with a standard 8x50 finderscope. To assemble and align the viewfinder, perform steps 1 through 6 below during the daytime.

1. Assemble the viewfinder by attaching all included thumbscrews onto the viewfinder bracket and



Fig 28: Slide viewfinder into receiver

insert the 8X50 viewfinder into the bracket. Tighten the thumbscrews to a firm feel only so the 8x50 optical tube is roughly centered in the middle of the bracket.

2. Slide the viewfinder bracket into its mounting assembly on the OTA (Page 7, Fig. 1, #1). To secure the viewfinder to the mounting assembly, tighten the two thumbscrews (Page 7, Fig. 1, #2) to a firm feel only.

Mount Additional Accessories and Equipment

At this time it is advisable to mount any additional accessories and equipment that you will be using during nighttime use. Balancing the telescope is the next step and it is important that this procedure be performed in its operational configuration.

Balancing the Telescope

Level the mount, using the integrated bubble level at the base of the mount as an aide if necessary, by adjusting the length of the three tripod legs.

Before using the telescope, you will need to balance the RA/DEC axes and the StarLock. Before you balance, attach the eyepiece assembly, the viewfinder and all the accessories you will be using with the telescope (cameras, guide scopes, etc.). In other words, you need to balance the unit with all the “weight” that will be attached to it.

To balance the telescope, unlock the Right Ascension or RA clutches (**3-Places, Page 14, Fig. 10**). When this axis is unlocked, the telescope pivots on the RA axis. Later in the procedure, you will also unlock the Declination or DEC clutches (**3-Places, Page 14, Fig. 10**). When unlocked, it pivots on the DEC axis. Try to become familiar with these locks and observe how the telescope moves on each axis. To obtain a fine balance of the telescope, follow the method below:

Balancing the RA Axis

1. Firmly hold the optical tube secure so that it cannot accidentally swing freely. **NOTE:** An unbalanced OTA can swing quickly causing injury to the user. Loosen the RA Clutch. The optical tube now moves freely about the RA axis. Rotate the telescope so that the counterweight shaft (**Page 20, Fig. 29**) is parallel (horizontal) to the ground.

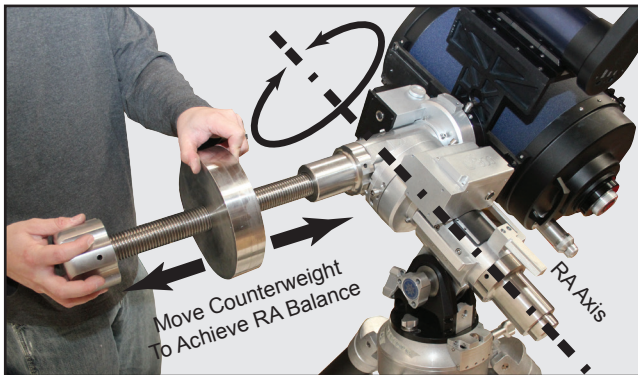

Fig 29: Balancing the RA axes

2. Rotate the counterweight along the counterweight shaft until the telescope remains in the horizontal position without moving in either direction. Now push the RA shaft from the end up and down. Adjust the counterweight position until it takes the same force to move the RA shaft up and down.

Balancing the DEC Axis

Again, hold the optical tube so that it cannot accidentally swing freely. **NOTE:** An unbalanced OTA can swing quickly causing injury to the user. Position the RA axis parallel to the ground and tighten the RA locks. Unlock the DEC Clutches. The telescope now is able to move freely about the DEC axes. Position the OTA parallel to the ground.

Advanced Coma-Free OTAs: Slightly loosen the OTA dovetail adapter lock knobs (**Page 8, Fig. 29**) so that the tube assembly slides easily back and forth in the

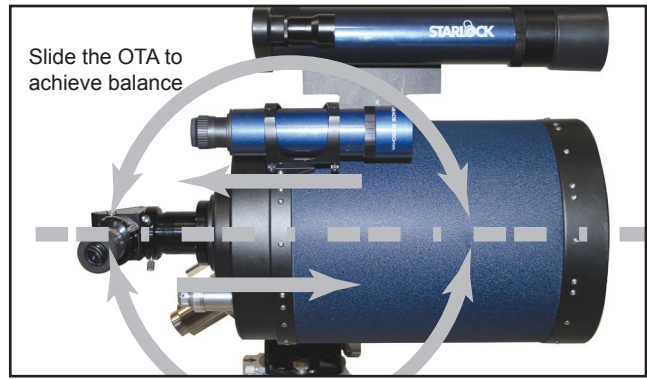

Fig 30: Balancing the DEC axes

dovetail mount. Be careful that the OTA does not fall out of the dovetail adapter! Start with 1/2" of the OTA dovetail plate extended out of the DEC Saddle (See **Appendix F, pg 56**). Move the OTA assembly fore or aft, in the dovetail adapter until the telescope remains in horizontal position without tending to drift down in either direction. Once this is achieved tighten the OTA dovetail lock knobs firmly.

Meade Refractors: Slightly loosen the cradle ring lock knobs so that the main tube slides easily back and forth in the cradle rings. Move the main tube in the cradle rings until the telescope remains in one position without tending to drift down in either direction. Once this is achieved tighten the cradle ring lock knobs. If the refractor is equipped with a dew shield, make sure it is fully extended prior to balancing.

Balancing the StarLock

When the StarLock is mounted on the saddleplate it is mounted off-center from the DEC axis, it must be properly counter-balanced to achieve optimum performance. With the DEC axis lock still loose and with the RA axis parallel to the ground, rotate the OTA so that points directly upward (**Fig. 31**). Start by loosening and moving the rectangular StarLock counterweight so there is a 1/2" gap between the weight and the DEC Saddle plate screws (See **Appendix F**). Move the weight until the telescope remains pointing upward, without tending drift in either direction. Once this is achieved tighten the StarLock counterweight knob and re-lock the DEC clutches.

The telescope is now properly balanced. Return the LX850 to the original position with the counterweight shaft pointed to the ground and OTA pointed straight ahead.

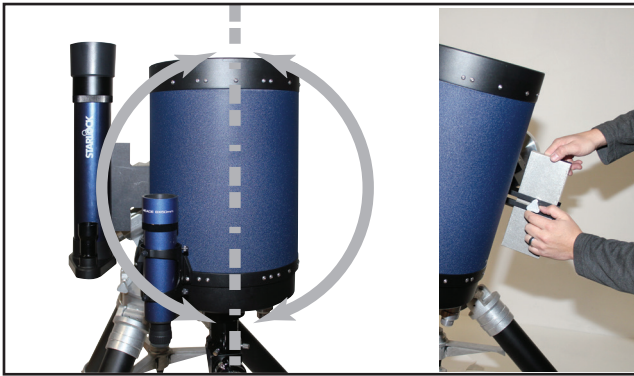

Fig 31: Balancing the StarLock assembly

Getting Started

Focusing and Aligning the Viewfinder

1. If you have not already done so, insert the Meade eyepiece into the diagonal mirror on the rear of the OTA.
2. With the telescope properly balanced in both axes (See the section “BALANCING THE TELESCOPE” BEFORE performing this step), Unlock the RA and DEC clutches (**Page 14, Fig. 10**) so that the telescope moves freely on both axes.
3. Point the telescope at some well-defined and stationary land object at least 200 yards distant, such as the top of a telephone pole or street sign. Center the object in the telescope eyepiece (See Focusing the Telescope section below). Re-tighten the RA and DEC clutches.
4. With the object centered in the telescope eyepiece, look through the viewfinder and loosen or tighten, as appropriate, one or more of the viewfinder collimation screws (**Page 7, Fig. 1, #2**) until the viewfinder crosshairs are precisely centered on the object you previously centered in the telescope eyepiece. Twist the rear section near the eyepiece clockwise or counter-clockwise to bring the object into clear focus.
5. Check this alignment on a celestial object, such as the Moon or a bright star, and make any necessary refinements.

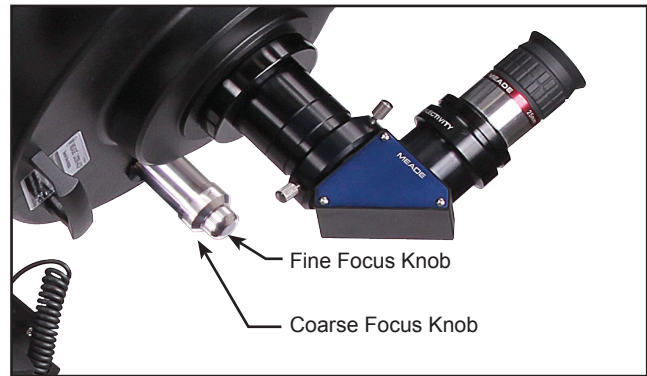

Fig 32: Dual speed Crayford focuser

Focusing the Telescope

Meade Advance Coma-Free (ACF):

Note: All LX850 ACF optical tube assemblies ship from our factory with a Travel Screw. This screw **MUST** be removed before focusing the telescopes optics. For details see pages 3 and 10, fig. 6b.

These optical tubes are equipped with an internal Crayford-style, zero image shift primary mirror focuser with dual speeds (7:1 ratio). The unique zero image shift design eliminates the need for a primary mirror lock and prevents image shift while focusing.

To focus the telescope, turn the outside coarse focus knob in or out until the image is focused. For precise focus use the smaller fine focus knob for final focus.

Meade APOs: The Meade APOs are equipped with a precision, aluminum-machined dual speed (10:1 ratio) Crayford-style focuser which eliminates image shift during focusing.

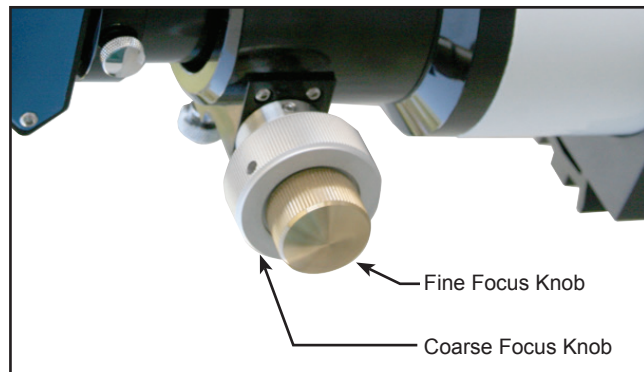

Fig 33: APO Crayford focuser

To focus the telescope, turn the outside coarse focus knob in or out until the image is focused. For

precise focus use the smaller fine focus knob for final focus. If you have a 2" eyepiece, remove the 1.25" eyepiece adapter from the diagonal by loosening the thumbscrew(s). Slide the 2" eyepiece into the diagonal and tighten with the eyepiece locking screw(s).

The bottom side of the focuser has a locking knob which locks the focuser drawtube in place. Use this lock knob when the focuser is attached with heavy equipment to prevent unwanted movement to the drawtube.

Slew Speeds

AutoStar II has nine slew speeds that move the optical tube at rates that are directly proportional to the sidereal rate and have been calculated to accomplish specific functions. Press the Speed key (Number key "1") and then press a Number key (1-9) to change the slew speed, which is shown for about two seconds on AutoStar II's display.

The nine available speeds are:

- Number Key 1** = 1x = Guide Rate, programmable
- Number Key 2** = 2x = 2x sidereal (0.5 arc-min/sec or 0.008°/sec)
- Number Key 3** = 8x = 8x sidereal (2 arc-min/sec or 0.033°/sec)
- Number Key 4** = 16x = 16x sidereal (4 arc-min/sec or 0.067°/sec)
- Number Key 5** = 64x = 64x sidereal (16 arc-min/sec or 0.27°/sec)
- Number Key 6** = 1/4° = 15arc-min/sec
- Number Key 7** = 1/2° = 30arc-min/sec
- Number Key 8** = 1° = 60arc-min/sec
- Number Key 9** = 3° = 180arc-min/sec

Speeds 1, 2, or 3: Best used for fine centering of an object in the field of view of a higher power eyepiece, such as a 12mm or a 9mm eyepiece.

Speeds 4, 5, or 6: Enable centering of an object in the field of a low-to-moderate power eyepiece, such as the standard Super Plössl 26mm.

Speeds 7 or 8: Best used for rough centering of an object in the viewfinder.

Speed 9: Moves the telescope quickly from one point in the sky to another.

Aligning for the First Time

Anytime you have removed and reinstalled the StarLock or OTA, you should select "One Star Alignment" in the

Autostar's Setup/Align Menu. Once you do this at the end of each observing session you will need only to park your scope and your telescope will keep this alignment until the telescope axes are unlocked or the mount is moved. When you turn the telescope back on after parking, it will be aligned and ready to use. If you forget to park the scope, select Easy Alignment so long as the tripod and OTAs have not been adjusted.

Finding True North/Aligning on Polaris

To ensure maximum pointing accuracy and tracking it is important that your telescope's mount and OTA be aligned on Polaris, or if Polaris is not visible, true north.

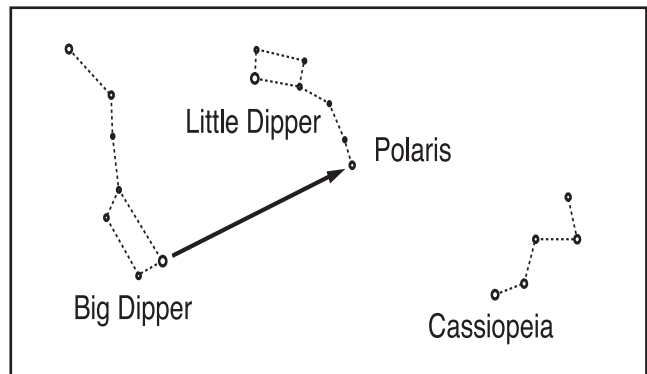

Fig 33A: Locating Polaris

Begin aligning the telescope by locating Polaris. Finding Polaris is simple. Most people recognize the "Big Dipper. The Big Dipper has two stars that point the way. Polaris is the last star in the "handle" of the Little Dipper (Fig. 33A).

Once you have located Polaris in the sky, orient your telescope so that the control panel faces south (away from Polaris). You may need to rotate the telescope mount on its tripod to achieve this orientation (loosen the two Azimuth Lock Knobs [page 7, fig. 1, 16], rotate and re-tighten the lock knobs). The telescope mount and its OTA are now pointing very near to the celestial north. Loosen the three (3) DEC locks (page 7, fig. 1, 23), rotate the OTA so that it is parallel with the mount (pointing towards Polaris) and then re-lock the DEC. If you were to have performed this maneuver perfectly, you would be able to see Polaris through the finder scope (make sure that you aligned the finderscope to the OTA). If you cannot, rotate the entire telescope/OTA assembly until you can.

You are now ready to perform AutoStar's One-Star alignment procedure.

One Star Alignment

To prepare your telescope for One Star Alignment:

1. Plug in the AC adapter to the control panel.
2. Verify both the RA and DEC clutches are tight.
3. Connect Autostar II to the HBX port of the control panel.
4. Flip the power switch of the control panel to the ON position. The Autostar II screen is activated and a copyright message displays briefly.
5. "Press 0 to Align or Mode for Menu" displays. Press 0.
6. The telescope will seek the home position and align with its internal sensors.
7. "GERMAN NORTH" is displayed. Instructions how to place your mount in the German home position scrolls in the lower portion of the display. Press ENTER. Since the mount has used its internal home position sensors to position it in the home position. Your mount has been factory calibrated to sufficient accuracy to provide a reasonable alignment. (press any Autostar II key to abort the Alignment).
8. Autostar now acquires a "GPS Fix." The LX850's GPS receiver acquires and syncs up with signals from GPS satellites.

After performing these operations, Autostar II now knows:

- The telescope's limiting positions
 - The observing site's location
 - The date and time
9. "CTR Polaris: Slewing" displays. When the telescope stops slewing, center Polaris in the eyepiece using only the mounts latitude and azimuth adjust knobs (**Page, Fig. 1, #17 and #34**). DO NOT USE THE HANDBOX TO CENTER POLARIS. When Polaris is centered lock the Altitude and Azimuth locks, then press ENTER.
 10. Autostar II then chooses another star to align upon. "Searching...." displays. The telescope then slews to a bright star for alignment. If it does not appear in the field of view in the eyepiece, look through the viewfinder—the star will be the nearest bright

star visible. Use the Arrow keys to move the telescope until the star is visible and centered in the eyepiece. The alignment star should be easily recognized and be the brightest star in the area of the sky where the telescope is pointing. Press ENTER. "Align Successful" displays. If "Align Unsuccessful displays," repeat the procedure.

NOTE: When the second star is centered and Enter is pressed, the StarLock is automatically aligned with the primary OTA. After the alignment, if you wish to realign the StarLock with the primary OTA after a GoTo to a star, press and hold the ENTER key on Autostar for 2 seconds, then release. "Enter to Sync" will display, press Enter. This aligns the StarLock to the Primary OTA and improves the mounts high precision pointing performance.

After your initial alignment, you can update the Home position for your scope, by selecting "Calibrate Home Position" from the SETUP/TELESCOPE menu. This will provide even more accurate results for subsequent alignments. This procedure only need be done once, or after recollimation of your optics or exchanging OTAs.

Syncing your Eyepiece or Camera using Starlock

Whenever you change eyepieces, diagonals or cameras, the center field of view may shift slightly. Starlock can compensate for this slight difference by performing the following routine:

1. Press the MODE key several times, until "Select Item: Object" is displayed.
2. Press the ENTER key to choose the "Object" option and move down four (4) levels. "Object: Star" is displayed.
3. Press the ENTER key to choose the "Star" option and move down one (1) level. "Named" is displayed.
3. Press the ENTER key to choose the "Named" option.
4. Scroll thorough the lists of Named star until you come to a bright star that is visible (if you are not sure what to choose use the same star that

AutoStar used during the alignment procedure). Press the GOTO key to choose that star.

5. The telescope will slew to that star. When slewing has been completed, re-center the star in the eyepiece or camera. Then hold the “ENTER” key for 2 seconds. Then press “ENTER” again to confirm your position.

StarLock will now compensate for the offset.

Test your Collimation

Before collimating an LX850 telescope, you will need to test your collimation.

To test the collimation, center a bright star that is overhead, with a medium/high power eyepiece such as a Meade 12mm eyepiece. Allow the telescope optics to adjust to the temperature of your observation site before proceeding; temperature differences between the optics and the outside air can cause distortion in the images. Autostar II offers an option in the Utilities menus that displays the “Ambient Temperature” (the temperature of the air around mount).

When the star is centered, de-focus the image. You will notice that the out of focus star image looks like a

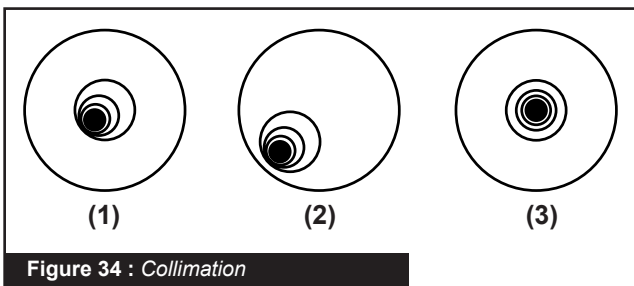

Figure 34 : Collimation

ring of light surrounding a dark central spot; the dark central spot is in fact the shadow of the secondary mirror. You may notice multiple rings; these are called diffraction rings. Focus until the diffraction rings fill about 10% of the eyepiece field-diameter. If the dark central spot is offset in (i.e., not concentric with) the diffraction rings, your telescope’s optical system is misaligned and requires collimation.

Collimation of the optical system: Meade ACF Models ONLY

- a. The only adjustments possible, or necessary, on the Advanced Coma-Free LX850 telescope models are from the three screws (**Page 8, Fig. 2, #35**) located at the edge of the inner surface of the secondary mirror housing.
- Caution:** Do not force the three collimation screws past their normal travel and do not loosen them more than two full turns in a counterclockwise direction or the secondary mirror may come loose from its support. You will find that the adjustments are very sensitive, usually requiring only one-half turn or less to produce the desired result.
- b. While looking at the defocused star image, notice which direction the darker shadow is offset in the ring of light or notice which part of the ring is the thinnest (**Fig. 34, #1**). Place your index finger in front of the telescope so that it touches one of the collimation set screws. You will see the shadow of your finger in the ring of light. Move your finger around the edge of the black secondary mirror support until you see the shadow of the finger crossing the thinnest part of the ring of light. At this point, look at the front of the telescope where your finger is aiming. It will either be pointing directly at a set screw, or it will be between two set screws aiming at the set screw on the far side of the black secondary mirror support. This is the set screw that you will adjust.
 - c. Using the AutoStar II’s Arrow keys at the slowest slew speed, move the defocused image to the edge of the eyepiece field of view (**Page 23, Fig. 34, #2**), in the same direction as the darker shadow is offset in the ring of light.
 - d. Turn the set screw that you found with the pointing exercise while looking in the eyepiece. You will notice that the star image will move across the field. If while turning the set screw, the defocused star image moves out of the eyepiece field, then you must use the slew keys on the AutoStar to return the star to the center of the field of view. If the screw you are turning becomes very loose, tighten the other two screws by even amounts. If the screw you are turning gets too tight, un-thread the other two by even amounts.
 - e. When you bring the image to center (**Page 23, Fig. 34, #3**), carefully examine the evenness of the ring of light (concentricity). If you find that the dark center is still off in the same direction, continue to make the adjustment in the original turning direction. If it is now off in the opposite direction, you have turned

too far and you need to turn in the opposite direction. Always double check the image in the center of the field of the eyepiece.

- g. You may find after your initial adjustment that the dark center is off in a new direction (e.g., instead of being off side-to-side it is now off in an up-and-down direction). In this case repeat steps b through f to find the new adjustment screw.
- h. Now try a higher power eyepiece (e.g., 9mm or less) and repeat the above tests. Any lack of collimation at this point will require only very slight adjustments of the three set screws. You now have good collimation of the optics.
- i. As a final check of alignment, examine the star image in focus with the higher power eyepiece as suggested under good viewing conditions. The star point should appear as a small central dot (commonly referred to as an “Airy disc”) with a diffraction ring surrounding it. To give a final precision collimation, make extremely slight adjustments of the three set screws, if necessary, to center the Airy disc in the diffraction ring. You now have the best alignment of the optics possible with this telescope.

Calibrate Home

After a precise polar alignment (drift alignment) you may want to calibrate the Home Sensors on your mount. This procedure sets the 90 degree declination position and the zero hour angle of the RA axis very accurately. When you perform future alignments, the system uses these positions to aid in a precise alignment.

Parking the Scope

Designed for a telescope that is not moved between observing sessions. Align the telescope one time, then use this function to park the telescope. Once parked, the screen prompts to turn off power.

The advantage of parking is that you do not need to align the telescope the next time you turn on Autostar; it remembers your alignment. Tip: When waking their telescope, some users select a bright star from the Objects menu and perform a GoTo on that star. If the star is not in the exact center of the eyepiece, move the star to the center using the arrow keys and then hold ENTER down for more than two seconds. This activates the Enter to Sync function and fine tunes and improves the telescope's alignment.

Important Note: When the “Park Scope” option is chosen and the display prompts you to turn off the telescope's power, Autostar II is unable to be returned to operation without turning the power off

and then back on.

Most users can use the default park position when parking their LX850. The default park position is identical to the home position; counterweight shaft pointing downward and ota pointing forward toward the celestial pole.

However, if you are storing your telescope in a location where it cannot be stored in the home position, for example, such as an observatory with a top that slides back, just move your telescope to the position you want to store it. Choose “Park Position” from the Setup: Telescope menu. When “Park Position” displays, use the down arrow key to scroll through the choices. Select “Use Current” if your position is anything other than the Home Position. If you are using the Home Position, select “Use Default.”

StarLock Operation

Your LX850 Telescope incorporates the advanced StarLock™ system that makes target acquisition and accurate autoguiding during exposures completely automatic. The StarLock system incorporates a narrow field 80mm f/5 optic and a super wide-angle lens that automatically finds your target with high precision, locks on to a field star and automatically begins guiding.

StarLock Menu:

Press RET/GUIDE (Number key “7”) to select this menu directly from Autostar II's keypad. This “Hot Key” provides the ability to control the StarLock system easily and directly from any place within the Autostar menus. From this key, you can:

- Turn StarLock guiding on and off. Enable and disable StarLock High Precision Pointing
- Monitor StarLock corrections
- Set Different Guide Speeds

Key to StarLock Indicator Lamps

On the back surface of the StarLock assembly, between the two (2) receptacles is a single red LED indicator lamp. Below is a guide showing what the lamp blink patterns are indicating:

- No illumination StarLock is turned off, does not have power or is idle awaiting commands.
- Blinking StarLock is searching for a suitable guide star (either for guiding or HPP centering).
- Solid StarLock has located and locked onto a guide star.

StarLock Automatic Rate Calibration (ARC)

Obtaining best performance from StarLocked telescopes requires that the guiding aggressiveness be optimally set for current viewing/imaging conditions. This is an essential procedure to obtain peak tracking accuracy

Please refer to Appendix C, page 53 for details.

Periodic Error Correction

Training the mount using AutoStar's built-in Periodic Error Correction is necessary to achieve peak performance of the LX850 Telescope System. This is especially true when you are taking long exposure photography.

Periodic Error Correction should be done after you have fully assembled your mount, balanced with all the auxiliary equipment you plan on using and you have successfully aligned the telescope. It is also important that this performed under reasonably dark skies with good seeing conditions. If atmospheric conditions are poor you will not obtain accurate error correction. See page 43 for directions on how to perform the Periodic Error Correction routine.

StarLock And Mount Flexure

The StarLock is normally attached to the saddle plate of your mount. When enabled, it waits a few seconds after the completion of a slew, and then automatically finds a guide star and begins auto-guiding your telescope. This assures that your mount will precisely compensate for the movement of stars across the sky. Provided your telescope is securely attached to the mount, it too will track precisely with the movement of stars across the sky. If the position of your OTA, camera, diagonal or eyepiece changes over time, you will see a small drift in the position of objects. This problem is known as differential flexure.

Meade's LX850 OTAs have been engineered to limit flexure sufficiently to make images up to 10 minutes or longer in duration without any noticeable movement of objects. Often, depending upon where you are pointed you can go much longer. If you are experiencing drift due to flexure, you need to track down what is loose and tighten it up. Things to check include:

StarLock Mounting

The StarLock's Dovetail should be centered in the dovetail bracket with its base flush against the bottom of the saddle plate. Be sure the dovetail bracket is tight

and no movement of the StarLock is occurring.

Note that 10", 12" and 14" LX850 ACF optical tubes include their own StarLock mounting bracket located at the top of the OTA, towards the rear cell. This second bracket is the preferred mount location for StarLock as it minimizes flexure in these long focal length OTAs,

OTA Mounting

Likewise, the OTA's dovetail plate should be flush against the Saddle Plate and the Dovetail bracket should be tight. Additionally, you should check that the cap head screws securing the dovetail to the telescope are tight. This includes the plate interface brackets that connect the OTA to dovetail plate.

Focusers

If you are using a refractor, be sure that the focus lock is tightened once you have achieved focus. Crayford-style focusers are secured via pressure on a rolling pin. Too much force and the scope will not focus, too little and the focuser tube can shift as you scope tracks around the sky, especially with a heavy camera hanging off the end.

Cameras

Be sure your camera is securely attached to the telescope. Inserting the camera in a draw tube and tightening a single captive screw is a recipe for image shift. Draw tubes should have at least two and preferably three captive screws so the camera cannot shift when the scope moves about the sky.

Reflecting Telescope Mirrors

If you are using a telescope with primary mirror atop the LX850 that does not have Meade's "Zero Shift" technology, you must lock your mirror, otherwise as the scope moves about the sky, the different stresses will cause the mirror to flop making long exposures impossible.

Heavy OTAs

If you are using a very heavy OTA, near the 90 pound limit of the LX850's capacity, it may prove difficult to prevent differential flexure. If this is the case, you can improve performance by attaching the StarLock to the top of your OTA. While this makes it inconvenient to exchange OTAs, it may resolve many flexure problems. The orientation of the StarLock should not change. It should still be square to the Saddle Plate. Attaching the StarLock to your OTA will mean that it will not only compensate for star movement relative to the mount, but star movement relative to the OTA itself.

AutoStar II Operation

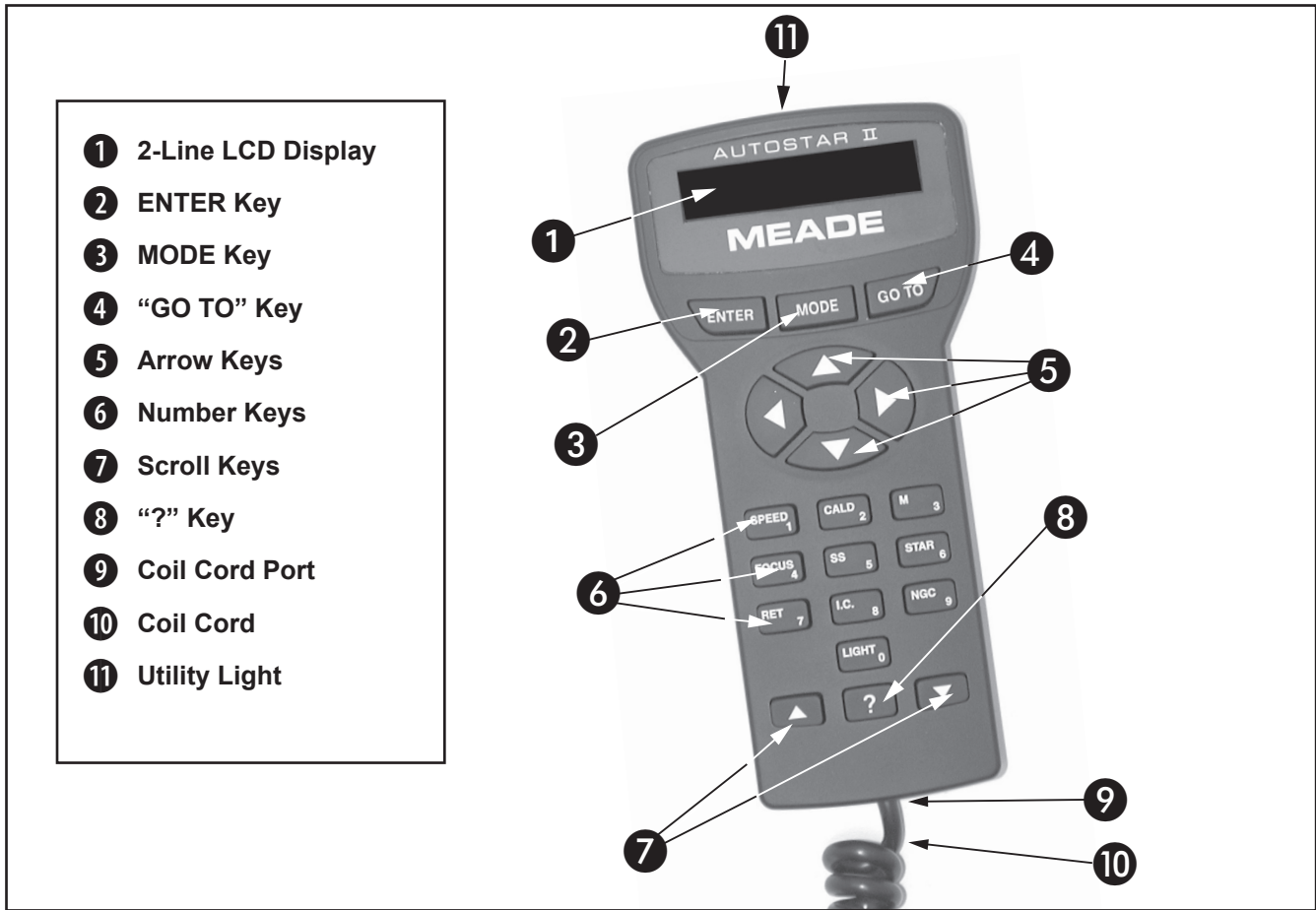

Figure 35: The AutoStar II Handbox

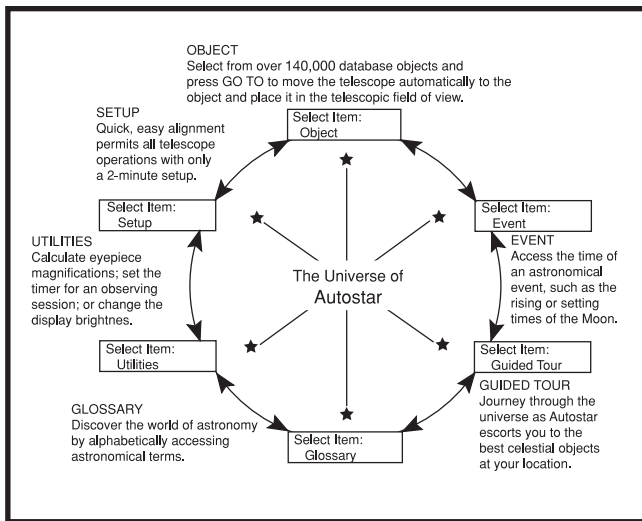

Fig. 36: The AutoStar Universe: The six primary categories listed in the Select Item menu of AutoStar.

It is important to understand that menu selections are set in a loop (Page 28, Fig. 38). This means that pressing the Scroll Down key (Fig. 35, #7) cycles down through all the available options within a given

category, then returns to the first option. The Scroll Up key (Fig. 35, #7) cycles up through the options in the opposite order. Note that this capability is a quick way to get to an option that is near the bottom of the list. The following example demonstrates this capability.

Example:

To navigate to the “Select Item: Setup” menu option when the “Select Item: Object” menu is displayed:

1. Press the Scroll Down key four times or the Scroll Up key once.

The screen (Fig. 35, #1) displays two lines of information. The top line shows the current menu level. The second line displays an option which may be selected within that menu level.

Some options are choices that select the next menu level down. The Scroll keys move up and down within the list of available options, showing one option at a time.

When the desired option is displayed on the second

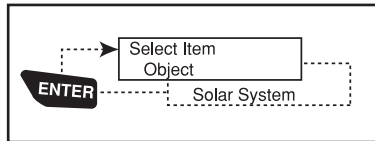

Figure 37: AutoStar Levels

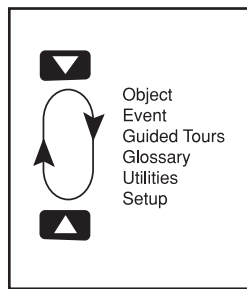

Figure 38: Menu set in loop

line, press the ENTER key to choose that option and move down one menu level. In the example, press Enter and the display now reads “Object: Solar System.” You have moved down to the Object menu level (**Fig. 37**). You can now use the up and down keys to scroll through the other options available for the Objects menu: Constellations, Deep Sky, etc.

Press the MODE key to leave a level; e.g., the wrong menu option is chosen.

Important Note: No matter how many levels into AutoStar are traveled, each press of the MODE key moves up a level, until the top level, “Select Item”, is reached. Once in the Select Item level, press MODE to return to the topmost level, “Select Item: Object”.

AutoStar Navigation Exercise

To demonstrate how the AutoStar menu structure works, the following exercise calculates Sunset time so an evening observing session can be planned.

To Calculate Sunset time:

1. Press the MODE key several times, until “Select Item: Object” is displayed.
2. Press the Scroll Down key once to display the “Event” option in the “Select Item” menu.
3. Press the ENTER key to choose the “Event” option and move down a level. “Event: Sunrise” is displayed.
4. Press the Scroll Down key once to display the “Sunset” option in the Event menu.
5. Press the ENTER key to choose the “Sunset” option and move down another level.
6. AutoStar calculates the Sunset time based on the current date, time, and location. AutoStar then displays the results of the calculation.

7. Press MODE once to start moving back up through the AutoStar levels. The first level up is the Event menu.
8. Press MODE again to move up another level. This is the top level, “Select Item”.
9. Press MODE again to return to the starting point of “Select Item: Object”.

Example of Locating a menu

As you typically will be using menus after you initialize and align your telescope, this example will assume you have just completed aligning your scope. AutoStar II displays “Select Item: Object” after the alignment procedure; this will be our starting point. In this example, we will locate the “Owner Info” option. Please reference **page 27, figure 35** for the location of the Autostar II keys used in this example.

1. “Select Item: Object” displays.
2. As the Owner Info option is in the Setup menu, you will have to use one of the Scroll keys to navigate through the list of menus. Press the Scroll Down Key. “Select Item: Event” displays
3. Keep pressing the Scroll Down key. Notice that all the menus display as you press the key: Guided Tour, Glossary, Utilities, Setup. Stop when “Select Item: Setup” displays. If you press the Scroll Down key one more time, “Select Item: Object” will display again. This is because the list of menus or options cycles through each choice over and over again when you press one of the Scroll keys.
4. With “Select Item: Setup” displayed, press ENTER. Pressing ENTER selects the menu or option currently displayed.
5. “Setup: Align” displays.
6. Press the Scroll Down key again. “Select Item: Telescope” displays. Press ENTER. Autostar II will now display all the choices that are available with the Telescope menu.
7. Continue to press the Scroll Down key until “Setup: Owner Info” displays.
8. Press ENTER. “Owner Info: Name” displays. Press ENTER again. “Name” displays, with the second line blank. On this line you may enter your first and last name into Autostar II’s memory.

AutoStar II MENU TREE

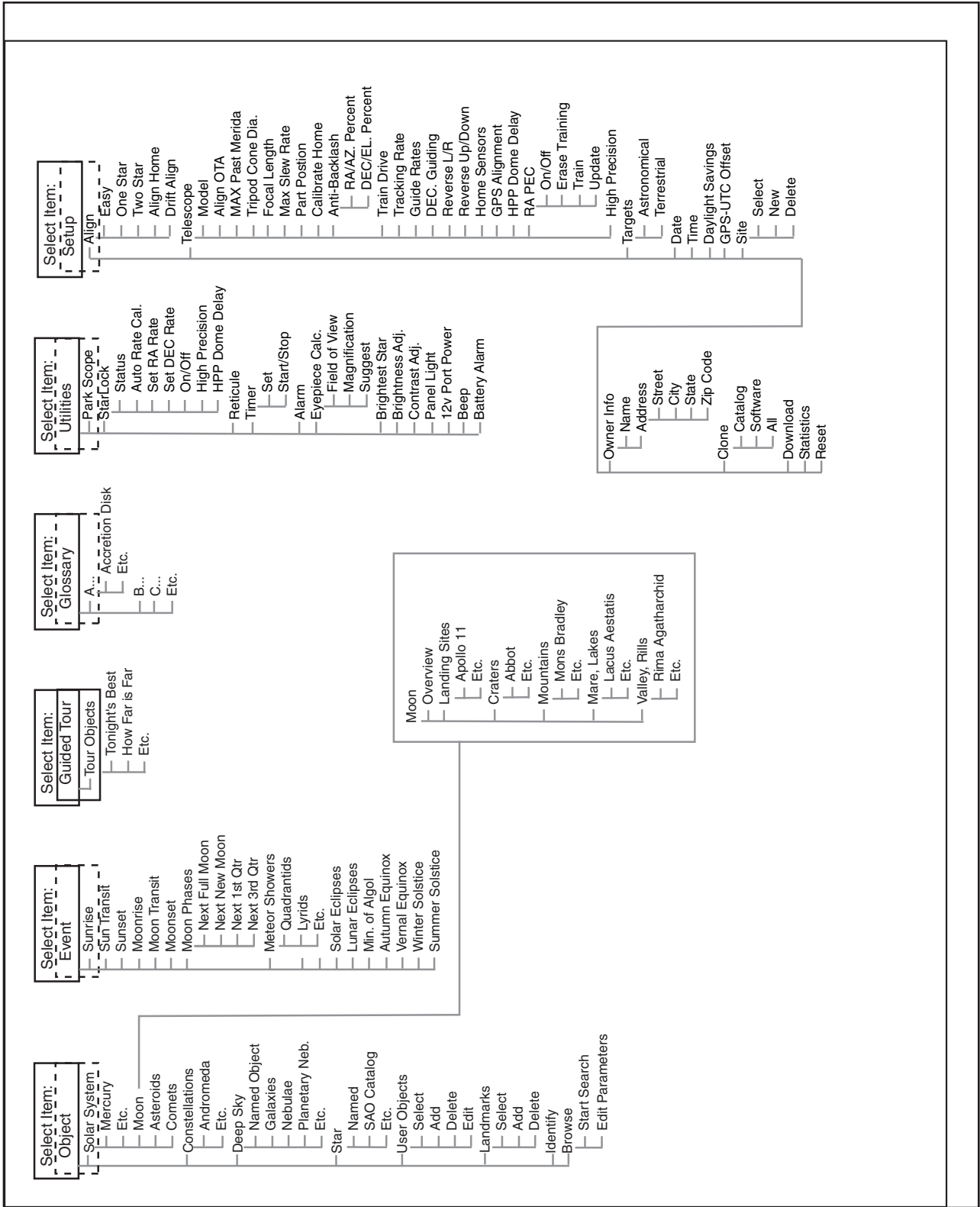

Figure 39: The AutoStar II Menu Tree

9. Press the Up or Down Arrow key. Notice that a letter of the alphabet displays. Continue to press one of the Arrow keys until the first letter of your name displays.
10. Use the Right Arrow key to move to the next position so you can choose the second letter of your name. Continue to use the Arrow keys to enter your full name.
11. Press ENTER when you are finished. Your name is now entered into AutoStar II's memory.
12. "Owner Info: Name" displays again (if you wish, you can press the Scroll Down key—"Owner Info: Address" will display and you can enter your address if you wish).
13. Press MODE and "Setup: Owner Info" displays. Press MODE again. "Select Item: Setup" displays. MODE allows you to backup and exit through the menu structure.

Navigating Autostar II

Autostar II's menus are organized for quick and easy navigation:

- Press ENTER to go deeper into Autostar II's menu levels.
- Press MODE to move back toward the top menu level.
- Press Number key "1" to engage the Speed mode, and then press Number keys 1 through 9 to change speeds.
- Press Number key "4" to access the Focus menus.
- Press Number key "7" to access the StarLock menu.
- Press the Scroll keys to move up and down through the options or lists.
- Press the Arrow keys to move the cursor across the display.
- Press the Help (?) key to access on-line help.

Object Menu

Almost all observing with Autostar II is performed using the Object menu category. (Note: Exceptions include Guided Tour and Landmark Survey.)

Autostar II contains many libraries of viewable objects, such as stars, planets, comets, nebulae and so forth.

When one of these objects is selected from a library, Autostar II moves your telescope (if properly aligned) and points it at the selected object. Six of the most popular libraries can be accessed directly using the hot buttons.

The Object Menu options include:

Solar System: A library of the eight planets (Earth is not included) in order out from the Sun, followed by the Moon, asteroids, and comets (Number key "5").

Constellation: A library of all 88 Northern and Southern Hemisphere constellations. When this menu option is chosen and a constellation name appears on the first line of the screen, press GO TO and the telescope goes to the center of the constellation and will display coordinates. Then, use the Scroll keys to cycle through the list of the most significant stars in the constellation. Then it will display deep space objects and so forth in the constellation.

Deep Sky: A library of objects outside our Solar System such as nebulae, star clusters, galaxies, and quasars.

Star: A catalog of stars listed in different categories such as named, double, variable, or nearby. Also included are the Hipparcos, SAO, HD, and HR catalogs. The Star catalog may also be accessed directly by pressing Number key "6."

Satellite: A library of Earth-orbiting objects such as the International Space Station, the Hubble Space Telescope, Global Positioning System (GPS) satellites, and geosynchronous orbit satellites.

Other **Catalogs** are accessed directly using the Autostar II "hot keys": Caldwell (key "2"), Messier catalog ("3"), Solar System ("5"), IC ("8"), and NGC ("9").

To slew the telescope to catalog objects:

Enter the catalog number of the object using the Number keys and then press ENTER. For example: To slew to NGC 6720, press Number Key "9," then using the Number keys, enter the digits "6-7-2-0." Then press ENTER.

Autostar II displays the common name and alternate names of the object, if available. Press one of the Scroll keys to display some or all of the following information about that object: Type of object (galaxy, nebula, etc.), DEC and RA coordinates, constellation it is located within, magnitude, size, distance, and

star-type classification, if the object is a star. If further information is available, it displays as scrolling text.

Press GO TO. The telescope, if aligned, will slew to that chosen object. Press MODE repeatedly to return to previous menu levels.

User Objects: Allows the user to define and store in memory deep-sky objects of specific interest that are not currently in the Autostar II libraries. See **CREATING USER OBJECTS**, page 37, for more information.

Identify: An exciting feature for an observer who wants to scan the night sky and start exploring. After the telescope has been properly aligned, use the Autostar II Arrow keys to move about in the sky. Then follow this procedure:

Important Note: Only use the Arrow keys to move the telescope during the Identify procedure. Do not loosen the telescope locks or move the base or alignment is lost.

1. When a desired object is visible in the eyepiece, keep pressing MODE until the "Select Item: Object" menu is displayed. Press ENTER to select this menu.
2. Scroll through the Object menu options until the "Object: Identify" screen appears.
3. Press ENTER. Autostar II searches the libraries for the identity of the object being observed.
4. If the telescope is not directly on an Autostar II library object, the nearest library object is located and displayed on the screen. Press GO TO and the telescope slews to that object.

Browse: Allows you to search the library for objects with certain parameters, much like a search engine. "Edit Parameters" lets you set various parameters for the search, such as: Object Type, Minimum Elevation, Largest, etc. Once you have set the parameters of the search, select "Start Search" and press ENTER. Autostar II will display the results of the search.

Event Menu

The Event menu provides access to dates and times of astronomical events. The Event database includes:

Sunrise, Sun Transit, and Sunset: Calculate the time of Sun rise, Sun transit, or Sun set on the current date. Find rise and set times for other dates by entering a new date into the "Setup: Date" menu.

Moonrise, Moon Transit, and Moonset: Calculate the time of Moon rise, Moon transit, or Moon set on the current date. Find rise and set times for other dates by entering a new date into the "Setup: Date" menu.

Moon Phases: Displays the date and time of the next Full, New, 1st Quarter, and 3rd Quarter Moon.

Meteor Showers: Provides information on upcoming meteor showers, such as the Perseids, the Leonids, etc. Also lists the dates of the showers and when they reach maximum.

Note: Meteors are fast moving objects that cover large areas of the sky and are usually best observed with the naked eye.

Solar Eclipse: Lists upcoming Solar Eclipses, including the date and type (total, annular, or partial) of eclipse. Use the Scroll Up and Down keys to display the available data. This option is dependent on your location.

Lunar Eclipse: Lists upcoming Lunar Eclipses, including the date and type (total, partial, penumbral) of eclipse. Use the Scroll Up and Down keys to display the available data.

Min. (Minimum) of Algol: Displays the minimum brightness of the dramatic eclipsing binary star system, Algol. It is relatively close at a distance of 100 light years. Every 2.8 days during a 10-hour period, Algol undergoes a major change in apparent magnitude as one of the two stars passes behind the other. The combined magnitude of the two stars thus dips from +2.1 to a minimum of +3.4 halfway through the eclipse as the second star is hidden. Autostar II calculates minimum magnitude time at mid-eclipse.

Autumn and Vernal Equinox: Calculate the time and date of the fall or spring equinox of the current year.

Winter and Summer Solstice: Calculate the time and date of the winter or summer solstice of the current year.

Glossary Menu

The Glossary menu provides an alphabetical listing of definitions and descriptions for common astronomical terms and Autostar II functions. Access directly through the Glossary menu or through *hypertext words* embedded in Autostar II. A hypertext word is any word in **[brackets]**, usually found when using the Autostar II Help function or when reading a scrolling message

such as a description of a planet or star. Press ENTER whenever a hypertext word is on screen and Autostar II goes to the glossary entry for that word.

To access directly from within the Glossary menu, use the Scroll keys to scroll through the alphabet. Press ENTER on the desired letter. Scroll to the desired entry and then press ENTER to read the description.

Utilities Menu

The Utilities menu provides access to several extra features within Autostar II, including a countdown timer and an alarm. The Utilities functions include:

Park Scope: Designed for a telescope that is not moved between observing sessions. Align the telescope one time, then use this function to park the telescope. The next time it is powered up, pressing ENTER causes the telescope to move to its predetermined Park position. Once parked, the screen prompts to turn off power.

Important Note: When the “Park Scope” option is chosen and the display prompts you to turn off the telescope’s power, Autostar II is unable to be returned to operation without turning the power off and then back on.

StarLock: Provides the ability to control the StarLock system

- Status
- Auto Rate Calculation
- Set RA Rate
- Set DEC Rate
- Turn StarLock guiding on and off.
- Enable and disable StarLock High Precision Pointing
- HPP Dome Delay

Timer: Selects a countdown timer. This feature is useful for functions such as astrophotography and tracking satellites. To use the Timer, press ENTER, then choose “Set” or “Start/Stop.”

- Set: Enter the time to be counted down, in hours, minutes, and seconds, then press ENTER.
- Start/Stop: Activates the timer set previously. Use the Scroll keys to toggle between ON and OFF.

When ON is displayed, press ENTER to activate the timer. When the timer runs out, four beeps sound and the timer is deactivated.

Alarm: Selects a time for an alarm signal to sound as a reminder. To use the Alarm, press ENTER, then choose “Set” or “Start/Stop.”

- Set: Enter the time of day for the alarm to sound, in hours, minutes, and seconds, then press ENTER.
- Start/Stop: Activates the alarm set previously. Use the Scroll keys to toggle between ON and OFF. When ON is displayed, press ENTER to activate the alarm. When the alarm time arrives, Autostar II beeps. Press ENTER to deactivate the alarm.

Eyepiece Calc: Calculates information about an eyepiece for the specific telescope to which Autostar II is connected.

- Field of View: Scroll through a list of available eyepieces. When an eyepiece is selected, the field of view is calculated.
- Magnification: Scroll through a list of available eyepieces. When an eyepiece is selected, the magnification is calculated.
- Suggest: Autostar II calculates and suggests the best eyepiece for viewing, based on the telescope and the object being viewed.

Brightest Star: Gives you a choice of Autostar displaying “CTR Bright Star” or identifying the star by name during alignment.

Contrast Adj: Adjusts the contrast of the display using the Scroll keys. When complete, press ENTER.

Panel Light: Allows you to turn off LED panel light.

Aux Port Power: Allows you turn off and on the 12v DC OUT power port.

Beep: Turns the beep alerts on or off.

Battery Alarm: Turns battery alarm on or off.

Setup Menu

There are numerous other features available within the Setup menu, including:

Align: Lets you choose a method of alignment.

- Easy
- One Star
- Two Star
- Align on Home
- Drift Align

Telescope: Accesses several options, including:

- **Telescope Model:** Allows you to select the type of OTA mounted on LX850.
- **Align OTA:** Provides an alignment routine that adjusts the OTA so that it is orthogonal to the LX850 telescope mount. This routine should be run when you have changed your collimation or mounting significantly. Note that Meade LX850 ACF optical tube assemblies have screws that allow you adjust for orthogonality. If you are using an optical tube assembly other than a Meade LX850 ACF you will need to verify that there is a mechanical means to correct for orthogonality before using this utility

When you select this menu, Autostar will ask you to center two stars in the telescope that are on opposite sides of the sky.

Once you have centered them, the telescope will slew back to the first star. You will then be asked to center the star using the hex head screws located on the bottom side of the OTA dovetail. Using a hex head wrench, make adjustments to the dovetail so the star is centered in the vertical direction in the eyepiece (perpendicular to the plane of the saddle. Note: The vertical direction is when the 90 degree diagonal is positioned as shown page 18, figure 24. The dovetail adjustments will only move the OTA in this direction. The horizontal direction can not be adjusted using these adjusting screws and is compensated for during the electronic alignment routine. When complete, verify the dovetail is still securely attached to the OTA radius blocks.

- **Max Past Meridian:** Allows you to set how far the OTA axis can tilt past the meridian. 2° is the default setting.
- **Focal Length:** Displays the focal length of the

selected telescope.

- **Max Slew Rate:** Sets the upper limit for the slew rate. 3° degrees per second is the fastest setting.
- **Park Position:** After aligning your telescope, select this menu and power down the telescope. The alignment settings—North, time, alignment stars—are stored in Autostar II's memory and are remembered after you power off the telescope. When you power on the telescope, "Automatic Alignment" displays after the start up routine. Press MODE (do not press ENTER). The telescope remembers its alignment and you can continue viewing or performing other operations without aligning the telescope again.

Park Position provides two options. Use Current Position uses the last position set by the user. Default Position places scope in the home position.

- **Calibrate Home:** For permanently mounted telescopes only. After aligning your telescope, select this menu and the alignment settings—North, time, alignment stars—are stored in Autostar II's memory and are remembered after you power off the telescope. You can enable Autostar II to retrieve and automatically align your telescope using these settings the next time you power up by choosing the Align on Home menu. This menu helps improve auto alignment.
- **Anti-Backlash:** This option allows you to change the backlash along either the RA and the DEC axes by entering a number from 0% to 199%. This sets the backlash in the way the Arrow keys move the telescope along an axis. If you enter a value near 199%, telescope responds more quickly as you hold down an Arrow key. If you enter a value near 0%, it takes longer for the tube to respond as you hold down an Arrow key. Experiment with this option: Try changing the values until the motion of the telescope (while holding down an Arrow key) feels comfortable to you.
- **Train Drive:** All telescopes have a certain amount of "backlash" (looseness in the interplay of gears). This menu allows you to compensate for the backlash in the RA and DEC motors—which helps locate objects with more precision.

- **Tracking Rate:** Changes the speed at which the telescope tracks targets in the sky.
 - a. Sidereal: The default setting for Autostar II; sidereal rate is the standard rate at which stars move from East to West across the sky due to the rotation of the Earth.
 - b. Lunar: Choose this option to properly track the Moon over long observing sessions.
 - c. Solar: Choose this option when observing the Sun. **(WARNING: NEVER USE A MEADE LX850 TELESCOPE TO LOOK AT THE SUN! Looking at or near the sun will cause instant and irreversible eye damage.)**
 - d. Custom: Allows entry of user-defined tracking rates.
- Note:** Custom Tracking Rate allows you to enter values from -999.999 to 999.999. The lower the number, the slower the rate; the higher the number the faster the rate. If you enter -999, the telescope will move so slow as to appear to be stopped. If you enter 999, the telescope will be moving at approximately twice the tracking rate.
- **Guiding Rate:** Allows you to change the base slew speed, 1x. Enter a percentage of the speed (less than 100%) and press ENTER. This function may be useful in guiding the telescope during CCD and long-exposure photography. See SLEW SPEEDS, page 22, for more information.
- **DEC Guiding:** Allows a user using an autoguider to disengage autoguider inputs. Allows you to select N & S, North only, South only, and off.
- **Reverse L/R:** Reverses the functions of the Left and Right Arrow keys for controlling the telescope's motion (i.e., the Right key moves the telescope to the left).
- **Reverse U/D:** Reverses the functions of the Up and Down Arrow keys for controlling the telescope's motion (i.e., the Up key moves the telescope down).
- **Home Sensor:** Turns off or on the True North sensor, if preferred, for Easy, One-Star, and Two-Star alignment. The default setting for this menu is "On."
- **GPS Alignment:** Allows three options. Select "Off"

if you wish to align the telescope manually (turns off GPS). Select "On" (default setting) if you wish to automatically align your telescope and want the telescope to get the GPS fix when it is needed during alignment. Select "At Start Up" if you want the telescope to get a GPS fix when the telescope is powered up.

- **HPP Dome Delay:** Allows time for the dome of an observatory-mounted telescope to catch up with the telescope before StarLock takes a high-precision star sighting. By default, this value is "0." The value should be set based on the worst-case rotation time of your dome. The time is entered in seconds of delay. Advanced software programs can release this hold early if the dome system is configured to notify the telescope when it is ready. See the Meade Telescope Protocol Specifications for details.
- **RA PEC:** Allows you to perform periodic error correction on the RA drive.
- **High Precision:** If High Precision is turned on, when looking for a faint celestial object (e.g., a nebula or galaxy), Autostar II first slews to a nearby bright star and displays "ENTER to Sync." Center the star in the eyepiece, then press ENTER. At that point the telescope has a high precision alignment to that part of the sky and it then slews to the object that was originally requested.

Targets: Switches between astronomical targets and Terrestrial targets. If "Astronomical" is selected, the telescope tracking motor is activated and any object you observe in the sky will remain centered in the eyepiece. If "Terrestrial" is selected, the tracking motor is turned off.

Date: Changes the date used by Autostar II. This function is useful to check events in the past or future. For example: Set the Date menu for a day three months in the future. Then check the "Select Item: Event" menu for the Sunset time on that date. See EVENT MENU, page 35.

Time: Changes the time entered into Autostar II. Setting the correct time is critical for Autostar II to properly calculate locations and events. Time may be set to "AM," "PM," or 24-hour mode (military time). To select the 24-hour mode, press ENTER when the "blank" option displays (i.e., neither "AM" nor "PM"

is displayed).

Daylight Saving: Enables or disables the Daylight Savings time setting.

Note: Daylight Savings Time may be referred to by different names in various areas of the world. Check local time to verify.

GPS-UTC Offset: Universal Time (UTC) allows you to add leap seconds to its time calculations, GPS does not. The offset is the number of leap seconds added since the establishment of GPS.

Site: Site provides access to several options including:

- **Select:** Displays the currently selected observing site. Use the Scroll keys to cycle through all available sites (see Add below). Press ENTER when the site you wish to select displays. Use this option when you move to a different geographic location.
- **Add:** Allows you to add new observing sites to the database. Scroll through the list of Countries/States. Press ENTER when the site you wish to add displays. Then choose the desired city in the same manner.

However, when the GPS signal is received, the site is normally selected automatically and the site list is updated automatically. Use of this option is not necessary and is included for the convenience of those users who may wish to enter a site manually. You may edit the name of a site using the Edit option (see below).

- **Edit:** Edits a selected site, including: the name, latitude, longitude, and time zone. Time Zone refers to the Greenwich Mean Time (GMT) time zone shift. Users West of Greenwich, England use “-” hours, East of Greenwich use “+” hours. For the United States, look up the time zone shift in Table 1.

Note: Autostar II compensates for daylight savings time, if selected. See Setup Menu: Daylight Saving, above.

Owner Info: Accesses the owner information menu, including:

- **Name:** Users may enter both their first and last names using the Up and Down Arrow keys to cycle through the alphabet. Use the Right and Left Arrow keys to move through the text. Press ENTER when

the entry is complete.

- **Address:** Use the Up and Down Arrow keys to enter your street address, city, state, and zip code. Press ENTER when the entry is complete.

Clone: Uploads information from one Autostar II handbox to another. Three options are available:

- **Catalogs:** Sends only user-defined object information, such as new satellite orbits or comet data to another Autostar II handbox.
- **Software:** Sends only the basic Autostar II software. This is useful if one user has downloaded a new version of Autostar II software from the Meade website (www.meade.com) and wants to pass this software along to friends.
- **All:** Everything—user-defined information and Autostar II software—is sent to another Autostar II.

Download: Transfers information from another Autostar II. During the operation, the warning “Downloading Do Not Turn Off” appears.

- **Catalogs:** Receives only user-defined object information, such as new satellite orbits or comet data to another Autostar II handbox.
- **Software:** Receives only the basic Autostar II software. This is useful if one user has downloaded a new version of Autostar II software from the Meade website (www.meade.com) and wants to pass this software along to friends.
- **All:** Everything—user-defined information and Autostar II software—is received by another Autostar II handbox.

Statistics: Provides basic statistical data about Autostar II, including:

- **Characters Free:** Displays how much room is available in user-defined object memory.
- **Version:** Displays the current version of the Autostar II software.
- **Serial Number:** Displays the unit’s serial number.

Reset: Completely resets Autostar II. Most values entered into the menus revert to factory defaults. Autostar II requires initialization again after a Reset before proceeding with observations.

“Hot Button” Menus

Two menus, six object libraries and two functions can

be accessed directly using the Number keys (commonly referred to as “hot buttons”). The two functions, the Speed mode and the Utility light are described earlier in the manual.

Focus Control Menus: If you have installed the Meade Zero Image Shift Micro Focuser, Press Number key “4” to select these menus directly from AutoStar II’s keypad. Each time you press Focus, the key toggles between focus/focus speed menus. When “Focuser: Fast” displays, press the Up or Down Scroll keys to select a focus speed (fast, medium, slow or fine). When “Focuser: Position” displays, use the Up or Down Arrow keys to achieve fine focus of the object.

StarLock Control Menu:

- **StarLock On/Off:** Selecting this entry allows you to turn StarLock on or off. You may wish to disable StarLock if you imaging a planet, or using a alternative autoguiding system.
- **StarLock Status:** When you select this option, the handbox will display the real-time guide corrections being made by the StarLock. The corrections are expressed in arcseconds. Pressing MODE will return you to the regular menus.
- **Guide Rate:** This option allows you to control how aggressively the StarLock attempts to remove tracking errors. This value is typically about 66 to 75%. When seeing is good higher values produce best results. In poor seeing this number should be reduced so that you scope does not “chase seeing” resulting in poor tracking.
- **StarLock HPP:** This option allows you to turn StarLock high precision pointing on and off.
- **StarLock HPP Dome Delay:** After the telescope slews to, aligns on an object and begins guiding there will be a delay to allow the dome to move to the new OTA location.

StarLock Permanent Periodic Error Correction

StarLock will automatically perform the PEC feature on your mount. To use this feature, simply press ENTER. It takes about 7 minutes to train one cycle.

It is advised that you perform one training and then immediately follow-up with two updates for maximum Periodic Error Correction. The level of training is necessary for critical applications such as long exposure photography.

Periodic Error Correction is retained within AutoStar's memory until you overwrite it by performing additional training cycles.

Advanced AutoStar Features

Before trying out the examples in this section, familiarize yourself with the basic operations of Autostar II described earlier in this manual. The following examples assume that you have a basic knowledge of Autostar II and understand how to scroll to a desired menu or menu option, and how to enter numbers and text. It also assumes that you have initialized and aligned your telescope.

Adding Observing Sites

If you plan to observe using Autostar II at different geographic locations, you can store observation sites in Autostar II's memory to help simplify your telescope setup. Perform these procedures using the Site options (Add, Select, Delete, Edit) of the Setup menu.

To Add a Site to the user-defined site list:

In this example, you will choose a city and add it to the database list. You will then select the site to enable it.

1. Navigate to the "Setup: Site" menu. Press ENTER.
2. Scroll through the options until "Site: Add" displays. Press ENTER.
3. Scroll through the list of countries/states. Press ENTER when the country/state you wish to add displays.
4. Scroll through the list of cities. Press ENTER when the city you wish to add displays. The Site is now added to the database. You may add sites using this method.
5. To choose a site, navigate to "Setup: Select." Press ENTER. Scroll through the list of sites. When the desired site displays, press ENTER.

To Edit a Site:

In this procedure, you will enter a location that is not available in the Autostar II database by editing data of a nearby site. You will edit the location's name, latitude, longitude, and the time zone shift. You will then select the site to enable it.

You will need to know the latitude and longitude of your location to perform this procedure.

1. Using the Add option, choose a site on the list that is closest to your observing site and press ENTER so that the site is added to your observing sites list. Choosing a site already on the list (as opposed to using the "Custom" feature) makes it easier to edit, as the "Time

Zone" value may not need to be changed.

2. Scroll to "Site: Edit" and press ENTER. "Edit: Name" displays. Press ENTER.
3. The name of the site you have just entered to your list displays; if it does not, scroll to the site.
4. Using the Arrow keys, change the name of the site so that it now reads the name of your observing location. Press Enter. "Edit: Name" displays again.
5. Press the Scroll Down key and "Edit: Latitude" displays. Press ENTER.
6. Using the Number Keys, enter the latitude of your observing site and then press ENTER. "Edit: Latitude" displays again.
7. Press the Scroll Down key and "Edit: Longitude" displays. Press ENTER.
8. Using the Number Keys, enter the longitude of your observing site and then press ENTER. "Edit: Longitude" displays again.
9. Press the Scroll Down key and "Edit: Time Zone" displays. Press ENTER. (If the site you chose from the list in step 1 has the same Time Zone as the site you are editing, just press ENTER again to go on to the next step.) "Time Zone" refers to the Greenwich Time Zone shift. Users West of Greenwich, use "-" hours (one hour per time zone) and users East of Greenwich use "+" hours.
10. After entering the shift, press ENTER. "Edit Time Zone" displays.
11. Press MODE. "Site: Edit" displays.
12. Using the Arrow keys, scroll to "Site: Select." The site you have just edited displays. Press ENTER to select the site.

Creating User Objects

In this procedure, you will enter coordinates of celestial objects that do not appear in any of the Autostar II libraries. You will enter the object's name and RA and DEC coordinates (required information). You may also enter the object's magnitude and size (optional information).

Although Autostar II contains an extensive database of

celestial objects (stars, nebulae, planets, etc.) that you can observe, you may eventually want to view objects that are not part of a library. AutoStar II provides a feature that allows you to enter an object's RA and DEC coordinates in the "User: Objects" option of the Object menu and allows automatic slewing of the telescope to the user-entered coordinates.

In order to use this menu option, you first need to look up the RA and DEC coordinates of the object or objects you wish to observe. Check your local library, computer store, or bookstore for astronomy books, CD ROMs, or magazines (such as *Sky & Telescope* or *Astronomy*) to find coordinates of celestial objects. The objects/coordinates you enter become part of your own permanent database, called "User Objects."

To enter coordinates of an object into the "User: Objects" option of the Object menu:

1. Make sure AutoStar II has been initialized and the telescope has been aligned.
2. After the telescope is aligned, "Select Item: Object" displays. (If necessary, use the Scroll keys to scroll through the menus, as previously described, to find this option.) Press ENTER.
3. "Object: Solar System" displays. Keep pressing the Scroll Up key until "Object: User Object" displays and press ENTER.
4. "User Object: Select" displays. Press the Scroll Down key once. "User Object: Add" displays. Press ENTER.
5. "Name" displays on the top line and a blinking cursor on the second line. Use the Arrow keys, as previously described, to enter the name of the object you wish to add to the database. When you are finished, press ENTER.
6. "Right Asc.: 00.00.0" displays. Use the Number keys to enter the digits for the Right Ascension coordinate of your object. When you are finished, press ENTER.
7. "Declination: +00°.00'" displays. Use the Number keys to enter the digits for the declination coordinate of your object. If necessary, use the Scroll Keys to change "+" to "-." When you are finished, press ENTER.
8. AutoStar II then prompts you to enter the size of

the object. This step is optional. Use the Number keys to enter the size (in arcminutes), if so desired, and press ENTER to go to the next display. If you do not wish to enter this information, simply press ENTER.

9. AutoStar II then prompts you to enter the magnitude of the object. This step is also optional. Use the Number keys to enter this information, if so desired, and press ENTER to go to the next display. "User Object: Add" displays again.

To GO TO a user-entered object:

In this procedure, you will choose an object from the User Object list and GO TO the object.

1. With "User Object: Add" displayed, press the Scroll Up key once. "User Object: Select" displays. Press ENTER.
2. Use the Scroll keys (if necessary) to scroll to the desired object. Press ENTER.
3. The name of the object and the Right Ascension and declination coordinates display.
4. Press GO TO and the telescope slews to the object.

Using AutoStar to Find Objects Not in the Database

In this procedure, you will enter coordinates of celestial objects that do not appear in any of the AutoStar database lists. You will enter the object's name and RA and DEC coordinates (required information). You may also enter the object's magnitude and size (optional information).

Although AutoStar contains an extensive database of celestial objects (stars, nebulae, planets, etc.) that you can observe, you may eventually want to view objects that are not part of the database. AutoStar provides a feature that allows you to enter an object's RA and DEC coordinates in the "User: Objects" option of the Object menu and allows automatic slewing of the telescope to the user-entered coordinates.

In order to use this menu option, you first need to look up the RA and DEC coordinates of the object or objects you wish to observe. Check out the World Wide Web, your local library, computer store, or bookstore for astronomy books, CD ROMs, or magazines (such as *Sky & Telescope* or *Astronomy*), to find coordinates of celestial objects. The objects/coordinates you enter

become part of your own permanent database, called “User Objects.”

To enter coordinates of an object into the “User: Objects” option of the Object menu:

1. Make sure AutoStar has been initialized and the telescope has been aligned.
2. After the telescope is aligned, “Select Item: Object” displays. (If necessary, use the Scroll keys to scroll through the menus, as previously described, to find this option.) Press ENTER.
3. “Object: Solar System” displays. Keep pressing the Scroll Up key until “Object: User Object” displays and press ENTER.
4. “User Object: Select” displays. Press the Scroll Down key once. “User Object: Add” displays. Press ENTER.
5. “Name” displays on the top line and a blinking cursor on the second line. Use the Arrow keys, as previously described, to enter the name of the object you wish to add to the database. When you are finished, press ENTER.
6. “Right Asc.: 00.00.0” displays. Use the Number keys to enter the digits for the Right Ascension coordinate of your object. When you are finished, press ENTER.
7. “declination: +00°.00” displays. Use the Number keys to enter the digits for the declination coordinate of your object. If necessary, use the Scroll Keys to change “+” to “-”. When you are finished, press ENTER.
8. AutoStar then prompts you to enter the size of the object. This step is optional. Use the Number keys to enter the size (in arcminutes), if so desired, and press ENTER to go to the next display. If you do not wish to enter this information, simply press ENTER.
9. AutoStar then prompts you to enter the magnitude of the object. This step is also optional. Use the Number keys to enter this information, if so desired, and press ENTER to go to the next display. “User Object: Add” displays again.

To GO TO a user-entered object:

In this procedure, you will choose an object from the User Object list and GO TO the object.

1. With “User Object: Add” displayed, press the Scroll Up key once. “User Object: Select” displays. Press ENTER.
2. Use the Scroll keys (if necessary) to scroll to the desired object. Press ENTER.
3. The name of the object and the Right Ascension and declination coordinates display.
4. Press GO TO and the telescope slews to the object.

Landmarks

This menu option allows you to define and store terrestrial objects in the Landmark database. First, a landmark needs to be stored in memory using the “Landmark: Add” option. To view a landmark, use the “Landmark: Select” option. Landmarks may also be viewed using the “Landmark Survey” option in the Utilities menu.

To Add a landmark to the database:

In this procedure, you will store the location of terrestrial landmarks in AutoStar’s memory.

1. Set the telescope in the home position, if necessary. Note for future reference where the telescope is located and if you have aligned the telescope, which alignment method is used.

IMPORTANT NOTE: *To use the Landmark function, the telescope must be located and aligned exactly as when the landmark) was added to the database.*

2. Display the “Setup: Targets” menu option. Choose “Terrestrial” and press ENTER – “Setup: Targets” displays again. Choosing this option turns off tracking for astronomical objects and is not useful for the viewing of terrestrial objects such as those in the Landmark database. Be sure to change this option back to “Astronomical” when you wish to view celestial objects again.
3. Press MODE once. “Select Item: Setup” displays.
4. Press the Scroll Down key once and “Select Item: Object” displays. Press Enter. “Object:

- Solar System” displays.
5. Press the Scroll Up key twice and “Object: Landmarks” displays. Press ENTER. “Landmark: Select” displays.
 6. Press the Scroll Down key once. “Landmark: Add” displays. Press ENTER.
 7. “Landmark Name” displays. Using Arrow keys, enter a name for the landmark you wish to add to the database. When finished, press ENTER.
 8. “Center Landmark. Press Enter” displays. Using only the Arrow keys (do not manually move the telescope), move the telescope to the desired landmark and center the object in the eyepiece. Press Enter. The object is now stored in memory.
 9. “Landmark: Add” displays. If you wish to add more landmarks, repeat steps 5 through 7.

To Select a landmark from the database:

1. Make sure the telescope is located and aligned exactly as when the desired landmark was entered into memory.
2. Display the “Landmark: Select” menu option. Press ENTER.
3. Use the Scroll keys to scroll through the list of objects you have previously entered. When the desired object displays, press ENTER to select the object. Use the Scroll keys to scroll through location information about the object, if desired. Press GO TO to slew the telescope to the landmark.
4. Press MODE to exit.

To perform a Landmark Survey

This procedure allows you to perform a tour of the objects entered in the “Object: Landmark” menu option – note that the Landmark Survey will function only if you have previously entered objects in the Landmark menu.

1. Navigate to “Utilities: Landmark Survey” menu and press ENTER.
2. “Landmark Survey: Slewing...” displays. The telescope moves to the first object on the Survey list and displays the name of the object.

3. Press MODE to pause the Survey. Press Enter to restart the survey at the first object of the survey.

To check on the available amount of memory in AutoStar.

AutoStar has a limited amount of memory. Once you begin to store Landmarks, User Objects and other bits of information in AutoStar, you will begin to use up memory. This procedure allows you to check on how much memory is still available.

1. Navigate to the “Setup: Statistics” menu option and press ENTER.
2. “Statistics: 97.4K Char. Free” displays. This is the amount of memory that is still available to the user.

Identify

This procedure allows you to use AutoStar to identify objects you have found in the night sky using the Arrow keys. If the object is not in AutoStar’s database, AutoStar displays information about an object in its database that is closest to the one you queried about.

Important Note: *The telescope must be successfully aligned before the Identify feature can be used. Once aligned, it cannot be physically moved from that location. Moving the telescope disrupts the telescopes frame of reference to the night sky and will prevent it from identifying objects.*

In this procedure, you will center an object you wish to have identified by AutoStar in the telescope eyepiece and use the “Identify” menu to find out information about the object or the nearest object to it in the AutoStar database.

1. Center the object you wish to have identified in the telescope’s eyepiece.
2. Navigate to the “Object: Identify” option and press ENTER.
3. “Searching...” displays. When AutoStar finishes calculating, the name of the closest object displays.
4. Press a Scroll key to display information about this object. AutoStar displays some or all the following information about the object with each press of a Scroll key:

Displayed information:	Example:
Catalog or common name	Messier 107, NGC 6171, Orion Nebula, etc
Type of object.	Globular Cluster, Nebula, Black Hole, etc.
Right Ascension	16:32:4
Declination	13°03'
Constellation	Virgo, Orion, etc.
Magnitude	3
Size2'
Scrolling message.	"This Globular Cluster is 10,000 light years away..."

Browse

This menu allows you to search the libraries for objects with certain parameters, much like a search engine. "Edit Parameters" lets you set various parameters for the search, and "Start Search" activates the search. A typical search might be performed as follows:

1. Select "Browse" from the Object menu. Press ENTER. "Browse: Start Search" displays.
2. Press one of the Scroll Keys and "Browse: Edit Parameters" displays. Press Enter.
3. "Edit Parameters: Largest (mins)" displays. "Mins" stands for arcminutes. Press ENTER.
4. "Largest (mins)" and a value displays. Using the Number keys, enter a size in arcminutes. Autostar II will search for objects up to this size and no larger. Press ENTER.
5. "Edit Parameters: Largest (mins)" displays again. Press the Scroll Down key. "Edit Parameters: Smallest (mins)" displays. Enter the value for the smallest size of an object that Autostar II will search for in the database. Continue with "Brightest," "Faintest," and "Minimum Elevation," using the procedure described in steps 3 and 4.
6. After "Minimum Elevation," "Object Type" displays. Press ENTER. "+Black Hole" displays. If you do not wish to have "Black Holes" in your search, press ENTER and the "+" changes to a "-." Press the Scroll Down key to scroll to the next item. "+Diffuse Nebula" displays. Continue to scroll through the list and press ENTER if you wish to change the "+" to a "-" or vice-versa.

7. After you have scrolled to the last item on the "Object Type" list, press MODE twice and the Scroll Down key once. "Browse: Start Search" displays. Press ENTER. "Start Search: Next" displays. Press Enter. Autostar II searches the database and displays the first object that matches the search parameters you have entered. Use the scroll keys to display information about the object. Press MODE and "Start Search: Next" displays again. Press ENTER and the next item matching the parameters displays. Repeat this procedure to display all the objects. Press GO TO to slew telescope to a displayed object.
8. Press MODE repeatedly to leave this menu.

Alternate Polar Alignments

If you would rather set up your telescope without using the One-Star alignment routine, Autostar II offers alternative alignment methods for equatorial mounting. During some of these procedures, you will (unlike the Automatic and Easy alignment procedures) manually place the telescope in the home position.

Initialize Autostar II

First, you need to initialize Autostar II.

1. Plug in the AC adapter to the control panel.
2. Verify both the RA and DEC clutches are tight.
3. Connect Autostar II to the HBX port of the control panel.
4. Flip the power switch of the RA control panel to the ON position.

The Autostar II screen is activated and a copyright message displays briefly.

5. "Press 0 to Align or Mode for Menu" displays. Press Mode.
6. The telescope will seek the home position. The RA and DEC motors operate briefly and "Finding Home" displays.
7. "Align: One Star" displays.

You are now ready to align your telescope using one of the alternate polar alignment procedures.

One-Star Polar Alignment (Default)

Please see page 22 thru 23 for detailed instructions on how to set-up your telescope and perform this alignment. Briefly, One-Star Polar Alignment procedure requires you to align first on Polaris using the manual controls to center that star. Autostar then selects and slews to a second star which you center using the handbox.

Two-Star Polar Alignment

AutoStar chooses and slews to two bright star that it chooses based on time and location.

1. Alignment Option Screen. "Align Automatic" displays.
2. Select Alignment. Press the Scroll keys until "Align Two Star" displays. Press "Enter" to select.
3. Set the telescope in the German equatorial home

position and press "Enter".

4. "Taking GPS Fix" will display followed by "Selecting Star" upon successful GPS fix. The telescope will then slew to the first of two star.
5. AutoStar will beep when it has completed its slew. Center the first star using the hand controller. Press "Enter".
6. AutoStar will repeat the process with a second star.
7. AutoStar will then display how far the telescope's alignment is off the pole.

Align on Home

If Calibrate Home has been performed, power up your telescope and select this menu to return the previously calibrated home position. In other words, the telescope is fully aligned according to the setting that were stored in Autostar II's memory during the Calibrate Home procedure. See Calibrate Home, below, for more information.

How to Drift Align LX850 (Northern Hemisphere)

The LX850 with StarLock is specially equipped to perform an Automatic Drift Alignment. In the Autostar Setup menu, select "Drift Alignment" and the LX850 will guide you through a quick Automatic drift alignment procedure. This method is substantially quicker than the manual drift alignment method.

Before performing an Automatic Drift Alignment you must perform either a One-Star, Two-Star or an Easy Polar alignment.

During the Automatic Drift Alignment Procedure, LX850 will slew to a Southern star and Starlock will begin monitoring the stars' drift on its CCD chip. Autostar will then let the user know how many turns of the mounts' Azimuth Adjustment knob to make to improve the mounts' polar alignment.

Next, the LX850 will slew to an Eastern star and StarLock will monitor its drift on its CCD chip. Again, the StarLock will suggest to the user the appropriate number of turns, this time using the mounts Latitude Adjustment knob, to achieve the optimal polar alignment.

However, if you prefer to drift align the mount using the manual drift alignment procedure, see Appendix A, pg 49.

Easy Polar Alignment

Easy Alignment is similar to Two-Star Polar Alignment, except it requires no knowledge of the night sky. Autostar II, rather than the user, chooses two stars its library and merely asks the user to center them in the eyepiece.

To Download the Latest Version of Autostar II Software

Included with your telescope is a DVD ROM and a USB cable. You need to install the USB drivers, that are included on the DVD ROM, BEFORE plugging in the cable:

1. Select "USB Drivers" from the DVD ROM.
2. Follow on screen instructions (click "Next" and "Finish" buttons when asked to do so).
3. Select Autostar Suite on the DVD ROM to install Autostar Suite onto your PC. Follow the on-screen instructions.
4. Once the Autostar Suite software installs, double-click the new "Autostar Suite" icon on the desktop.
5. Go to the Telescope menu and select "Update Autostar." The "Autostar Update" screen displays. Click the "Upgrade Autostar Software Now" button.
6. The application detects your telescope type and the version of Autostar software on your handbox.
7. A window displays asking if you wish to download the latest version of Autostar from your hard drive (if you previously downloaded it separately from the Meade website) or from the Internet. Select one of the choices and follow the on-screen instructions.
8. The download will take about 10 minutes (download time depends on your Internet connection, speed of your computer and so forth). When the download is complete, the new version of the Autostar software displays.

Starlock Assisted PEC Training

Periodic Error Correction (PEC) helps to remove the slight perturbations in tracking that occur due to the mechanical nature of a telescope. Follow the steps below to perform this procedure using StarLock:

1. Point the telescope's OTA at a moderately bright star near 0 declination (celestial equator).

2. Wait for the StarLock indicator lamp to stop blinking and become solid red, which indicates that it has located and locked onto the guide star.
3. Using your AutoStar handbox, navigate to the "Setup: Telescope" menu. Press ENTER.
4. Scroll through the options until "Telescope: RA PEC" displays. Press ENTER.
5. Scroll through the options until "RA PEC: Train" displays. Press ENTER.
6. Scroll through the options until "RA PEC: Update" displays. Press ENTER.
7. Repeat step 6 one more time to improve the PEC training.

Update Menu Option

Use the Update option to further refine your training; it is recommended that you update your original training two or three times when first using your telescope. Update does not overwrite the data, but updates the training using information gathered from both the last and the current training sessions. Press the MODE key to exit from this option. If you wish to further refine your training, select this menu again and repeat the procedure.

Erase Menu Option

Select this option to erase all PEC training data.

On and Off Menu Options

Select "On" when you want the telescope to use the training information. Select "Off" when you do not want for the telescope to use the training information. Select "On" to enable the Smart Drive.

Optional Accessories

A wide assortment of professional Meade accessories is available for the LX850 telescope models. The premium quality of these accessories is well-suited to the quality of the instrument itself. To find out more information about these and other exciting Meade accessories visit Meade's website at www.meade.com.

Additional LX850 Counterweights: Designed to precisely fit the counterweight shaft. These 10-pound weights are threaded and constructed from solid

stainless steel.

Meade Series 5000 Premium Eyepieces: deliver all the amazing performance that the ACF and APO optical systems can provide with Fully-Multi Coated optics, wide fields and razor sharp images all the way to the edge:

- **Ultra Wide Angle:** Ultra Premium Series 5000 Eyepiece have an extremely large 82 degree Apparent Field of View, 6 & 7 element Super Fully-Multi-Coated



Series 5000 HD-60

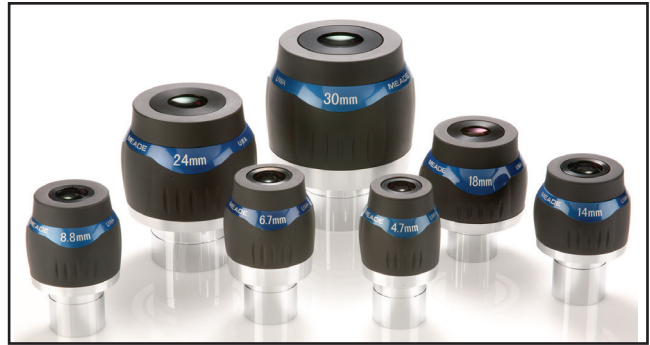

Series 5000 Ultra Wide Angle

Eyepiece	10" f/8	12" f/8	14"/f8	130mm/f8
	Power/ Actual Field	Power/ Actual Field	Power/ Actual Field	Power/ Actual Field
Series 5000 Xtreme Wide Angle Eyepieces - 100° AFOV (XWA) (9 elements; 2.0" O.D.,)				
9 mm	226/27'	271/22'	316/19'	101/59'
14mm	145/41'	174/34'	203/30'	65/1° 32'
20mm	102/59'	122/49'	142/42'	46/2° 12'
Series 5000 Ultra Wide Angle Eyepieces - 82° AFOV (6 or 7-elements; 1.25" O.D., except as noted)				
5.5mm (Waterproof)	369/13'	443/11'	517/10'	165/30'
8.8mm (Waterproof)	231/21'	277/18'	323/15'	103/48'
14mm (Waterproof)	145/34'	174/28'	203/24'	65/1° 16'
20mm (2" O.D.) (Waterproof)	102/48'	122/40'	142/35'	46/1° 48'
24mm (2" O.D.)	85/58'	102/48'	119/42'	38/2° 10'
30mm (2" O.D.)	68/1° 13'	81/1° 1'	95/52'	30/2° 42'
Series 5000 HD-60 Long Eyerelief Eyepieces - 60° AFOV (Fully Multi-Coated; 1.25" O.D.)				
4.5mm	452/8'	542/7'	632/6'	202/18'
6.5mm	313/12'	375/10'	435/8'	140/26'
9mm	226/16'	271/13'	316/11'	101/36'
12mm	169/21'	203/18'	237/15'	76/47'
18mm	113/32'	135/27'	158/23'	51/1° 11'
25mm	81/44'	98/37'	114/32'	36/1° 39'

lenses with blackened edges, rotating adjustable eyecups. Focal lengths from 5.5mm 1.25" to huge-field-of-view 30mm 2".

- **Xtreme Wide Angle:** Xtreme Wide Angle Series 5000 Eyepieces use 9 optical elements to achieve a high contrast image with razor sharp correction all the way to the edge of the huge 100 degree Apparent Field of View. The lenses are Super Fully Multi-Coated with blackened edges in 2" diameter format. Three focal lengths, 9mm, 14mm and 20mm are all parfocal.
- **HD-60:** The All New Series 5000 HD-60 Eyepieces have a large 60 degree Apparent Field of View that is flat and sharp to the edge, 17mm or more of eye relief for easy comfortable observing, Super Fully-Multi-Coated lenses with blackened edges, rotating adjustable eyecups. Focal lengths from 4.5mm to 25mm..

Series 5000 Auxiliary Equipment Mounting System:

All plates, rings and bases are precision milled from 6061-T6 Aircraft Grade aluminum, all joining surfaces are either precision chamfered or filleted to eliminate sharp corners and edges. Aluminum components are then carefully anodized black, and include stainless steel mounting hardware. Rings use three-point mounting with machined adjustment screws and include white colored Delrin® tips to prevent damage to scope finish. Bases for rings and counterweights include large lock knobs for easy adjustment.

#62 T-Adapter: The T-Adapter is the basic means of prime-focus photography through all Meade Schmidt-Cassegrain and Advanced Coma-Free models. Thread the T-Adapter on to the rear cell of your telescope, followed by a T-Mount for your 35mm camera, and the camera body is rigidly coupled to the telescope.

#777 Off-Axis Guider: The Off-Axis Guider provides a means during long-exposure astrophotography for the photographer to monitor the tracking of the telescope to assure that the telescope remains precisely positioned on the object being photographed. Like the T-Adapter, the Off-Axis Guider couples the camera body to the telescope but it also causes a small amount of the guidestar's incoming light to be diverted at a right angle, where the star's position can be examined for tracking errors with an illuminated reticle eyepiece; position corrections can then be effected using Autostar II.

Piggyback Brackets: Piggyback photography is one of the most popular and easiest ways to get started in astrophotography. Attach your 35mm camera, with its own 35mm-to-250mm lens, atop your LX850 in equatorial mode, and guide the telescope using StarLock's narrow-field camera. Wide-field photos of the Milky Way showing remarkable detail and clarity can be taken.

Dew Shields: In moist climates, water particles suspended in the atmosphere may condense on the front surface of the telescope's correcting plate. This dew formation may be inhibited to a significant extent by the addition of a dew shield, essentially an extension tube attaching to the front-cell of the telescope.

#905 Variable Polarizer (1.25"): The #905 system includes two polarizer filters mounted in a specially-machined cell, for glare-reduction in observing the Moon. Rotate the thumbscrew at the side of the unit to achieve light transmission between 5% and 25% of its original value. The #905 inserts into the diagonal mirror of the telescope, followed by an eyepiece.

Cigarette Lighter Adapter: Powering the LX850 telescope by means of an automobile cigarette lighter plug.

Astrometric Eyepiece: A high-precision 3-element achromatic eyepiece for a wide range of astronomical measurements. Measure double star separations, position angles, planetary diameters, lunar crater diameters and so forth. Includes variable LED illumination control and batteries.

More accessories will soon be available for your LX850 model. To find out more about these and other accessories available for your telescope, check out the Meade website at www.meade.com or contact your local Meade dealer.

MAINTENANCE

Your LX850 model telescope is a precision optical instrument designed to yield a lifetime of rewarding observations. Given the care and respect due any precision instrument, the telescope will rarely require factory servicing or maintenance. Use the following guidelines:

1. Avoid cleaning the telescope's optics: a little dust on the front surface of the telescope's correcting lens causes virtually no degradation of image quality and should not be considered reason to clean the lens.
2. When absolutely necessary, remove dust from the front lens with gentle strokes of a camel-hair brush or blow it off with an ear syringe (available at any pharmacy). Do not use a commercial photographic lens cleaner.
3. You may remove organic materials (e.g., fingerprints) from the front lens with a solution of 3 parts distilled water to 1 part isopropyl alcohol. A single drop of biodegradable dishwashing soap may be added per pint of solution. Use soft, white facial tissues and make short, gentle strokes. Change tissues often.

Caution: Do not use scented, colored or lotioned tissues or damage could result to the optics.

4. If your LX850 model is used outdoors on a humid night, telescope surfaces may accumulate water condensation. While such condensation does not normally cause any damage to the telescope, it is recommended that the entire telescope be wiped down with a dry cloth before being packed away. Do not, however, wipe any of the optical surfaces. Rather, simply allow the telescope to sit for some time in warm indoor air, so that the wet optical surfaces can dry unattended. In addition, the dust cap should not be placed back on to the optical tube until the telescope is thoroughly dry.
5. Do not leave your LX850 model outdoors on a warm day or inside a sealed car for an extended period of time; excessive ambient temperatures can damage the telescope's internal lubrication and electronic circuitry.

Storage and Transport

When the telescope is not in use, store it in a cool, dry place. Do not expose the instrument to excessive heat or moisture. It is best to store the telescope in its original box with the RA and DEC locks (**Page 14, Fig. 10**) in the unlocked positions. If shipping the telescope, use the original box and packing material to protect the telescope during shipment.

When transporting the telescope, take care not to bump or drop the instrument; this type of abuse can damage the optical tube and/or the objective lens and knock the optics out of alignment.

Inspecting the Optics

A few words about the so-called "Flashlight Test:" If a flashlight or other high-intensity light source is pointed down the main telescope tube, the view (depending upon the observer's line of sight and the angle of the light) may reveal what appear to be scratches, dark or bright spots or uneven coatings, giving the appearance of poor quality optics. These effects are only seen when a high intensity light is transmitted through lenses or reflected off the mirrors and can be seen on any high-quality optical system, including giant research telescopes.

The optical quality of a telescope cannot be judged by the "flashlight" test; the true test of optical quality can only be conducted through careful star testing.

CUSTOMER SERVICE

If you have a question concerning your LX850 telescope, call the Meade Instruments Customer Service Department at (800) 626-3233. Customer Service hours are 7:00 AM to 5:00 PM, Pacific Time, Monday through Friday. In the unlikely event that the LX850 requires factory servicing or repairs, before returning the telescope to the factory, write or call the Meade Customer Service Department to provide an explanation of the problem, as well as your name, address and daytime telephone number. The great majority of servicing issues can be resolved by telephone, avoiding return of the telescope to the factory.

SPECIFICATIONS

	10 inch Advanced Coma-Free	12 inch Advanced Coma-Free	14 inch Advanced Coma-Free	130mm APO
Product number	1008-85-01	1208-85-01	1408-85-01	0130-85-01
UPC	7 09942 60061 2	7 09942 60062 9	7 09942 60063 6	7 09942 60064 3
Optical design	Advanced Coma-Free			Apochromatic Refractor
Clear aperture	10 inches	12 inches	14 inches	130mm
Focal length focal ratio	2032mm, f/8	2438mm, f/8	2845mm, f/8	910mm, f/7
Optical coatings	UHTC			Fully Multi-Coated
Resolving power (Dawes limit)	.46 arcseconds	.38 arcseconds	.325 arcseconds	.89 arcseconds
Secondary obstruction (%)	20.95	16.86	13.8	NA
Viewfinder	8x50 refractor with cross hairs			
Eyepiece	HD-60 25mm long eye relief premium eyepiece			
Diagonal	Series 5000 2 inch with enhanced 99% reflectivity			
Field flattener (optional)	N.A.			3 inch diameter, 2 element, fully multi-coated field flattener
Focus system	Internal Crayford-style, zero image-shift primary mirror focus with dual speed 7:1 control			Crayford-style 3 inch zero image shift focuser with dual speed 10:1 control
OTA mounting	Losmandy®-style mounting plate			Vixen®-style mounting plate
Electronic zero image-shift microfocuser	Included			NA
Auxiliary equipment mounting system	Series 5000 Auxiliary Equipment Mounting System (optional)			NA
Materials				
Primary mirror	Low-expansion borosilicate glass			NA
Secondary mirror	Individually figured with primary mirror for minimum correction. Low-expansion borosilicate glass			NA
Correcting plate/lens	Aspheric high-spectral transmission Borofloat glass from Schott AG Germany			NA
Optical tube	Aluminum			
Weights and dimensions				
Total net OTA weight	33 lb	56 lb	63 lb	25 lb
OTA shipping weight (approx.)	44 lb	74 lb	79 lb	40 lb

SPECIFICATIONS

German Equatorial Mount		
Product number	37-0850-00	
UPC	7 09942 60060 5	
Mount body	Machined from solid 6061-T6 Aircraft grade Aluminum and stainless steel	
Finish	Anodized Aluminum and stainless steel	
Main gear - RA & DEC	5.8 inch under cut 225 tooth aluminum	
Worm gear - RA & DEC	.68 inch diameter precision machined brass	
Counterweight shaft	1.75 inch diameter, 12 inch long threaded stainless steel	
Counterweights	26 lb (optional 10 lb) threaded stainless steel. Quantity:	
	10 inch LX 850 ACF: two (2) 26 lb	12 inch LX 850 ACF: two (2) 26 lb
	14 inch LX 850 ACF: three (3) 26 lb	130mm LX 850 APO: one (1) 26 lb
	LX 850 Mount Only: one (1) 26 lb	
Counterweight shaft and cap weight	12.5 lb	
Drive motors	DC servo motors with encoders, both axes	
Mechanical alignment	Fine adjustment altitude and azimuth controls	
Tracking distance past meridian	20 degrees	
OTA mounting system	Losmandy®-style dovetail	
Instrument payload capacity	90.0 lbs (40.80 kg)	
Latitude range	10° - 70°	
Tripod	Giant folding adjustable height tripod with 3 inch diameter aluminum legs. Height from 29 inches to 45 inches.	
Mount body weight	60 lb.	
Tripod weight	36 lb	
Control panel	12v DC in, 12v DC out, Power, Focuser, Reticle, Handbox port, 1 computer connection port (RS232), 1 StarLock port, 1 Aux guide port	
Computer control	AutoStar II GoTo system	
Database	Over 144,000 Objects, Catalogs included: Index catalog (5,386); NGC catalog (7,840); Partial Caldwell catalog (109); Messier catalog (110); Earth orbiting satellites (26); Planets (9); Uppsala galaxy catalog (12,940); Morphological catalog of galaxies (12,939); General catalog of variable stars (29,364); SAO and Hipparcos star catalogs (42,277); Draper star catalog (21,160); Yale bright star catalog (8,977); Large Bright Quasars Survey (1,055); Named objects (4,313); Herschel catalog (400); Abell catalog of galaxy clusters (2,712); Arp catalog of irregular galaxies (635); Lunar features (1,754); Asteroids and comets (120); Constellations (88); Solar/Lunar eclipses, meteor showers (492).	
Computer hand control	Double line, 16 character Liquid Crystal Display; 20 backlit LED buttons.	
GPS	Yes	
Home sensors	Both RA and DEC axes	
Internal clock	Yes	
Internal cabling	Yes	
Slew speed	3 degrees/second	
Tracking rates	.01x to 1x, 2x, 8x, 16x, 1/4°, 1/2°, 1°, 3°.	
Tracking modes	EQ North and EQ South	
Alignment procedures	2-Star Align, 1 Star Polar Align, StarLock assisted drift align, Easy Alignment and Align on Home	
StarLock		
Wide-field camera	25mm x 26mm f/1.04 optic with 1/2 inch format sensor gives field of 14.72 x 11.78 degrees.	
Narrow-field camera	80mm x 400mm f/5 optic with 1/2 inch format sensor gives field of 57.2 x 45.8 arcminutes (2.68 arcseconds/pixel)	
Permanent Periodic Error Correction	Yes. Correction is retained in AutoStar's memory.	
High-precision pointing	+/- 1 arcminute	
High-precision guiding	+/- 1 arcsecond (with good seeing. 1-4 second correction update rate depending on star magnitude. Faintest guide star 11th mag.	
High-precision alignment	Semi-automatic drift align procedure for ultra-precise polar alignment	
Weight	2.9 lbs (1.3 kg)	
Power supply	12v DC 5A using supplied Meade Universal Power Supply	

APPENDIX A: Manual Drift Alignment

How to manually Drift Align the LX850 Telescope (Northern Hemisphere).

The LX850 with StarLock is specially equipped to perform an Automatic Drift Alignment. In the Autostar Setup menu, select "Drift Alignment" and the LX850 will guide you through a quick Automatic drift alignment procedure. This method is substantially quicker than the manual drift alignment method. However, if you prefer to drift align the mount using the manual drift alignment procedure, follow the steps below.

Important Note: You will need a reticle eyepiece to perform this procedure

1. Center your reticle on a bright star near the Eastern horizon.
2. Look through the reticle while pressing Autostar's right and left Arrow keys. This will slew the mount back and forth in the RA axis.
3. Loosen and rotate the reticle until one of the crosshairs matches the right-left path of the star as you press the Arrow keys. This crosshair is now on the RA axis. The other axis is therefore on the DEC axis. Carefully secure the reticle in place (do not move the crosshairs).
4. Observe the bright star you have chosen. If, over time, it drifts off the RA axis, use the latitude adjustment knob to bring it back past center. Experience will teach you how much to move the alt knob. If the star drifts slowly, use only a small amount of correction; if it moves quickly, use a much larger amount of correction.
5. Use Autostar's up and down keys to bring the star back to center. Perform step 4 repeatedly until it does not drift on the DEC axis for a few minutes.
6. Next, center on a bright, Southern star. This star should be within 10° to 20° of the celestial equator.
7. If the star drifts above the RA axis, use the Azimuth adjustment knob to move the star to the right and

down until the star is almost out of the field of view. If it drifts below the RA axis, use the Azimuth adjustment knob to move the star to the left and up.

8. Use Autostar arrow keys to center the star again. Repeat steps 7 and 8 until the star no longer drifts off the RA axis for a few minutes.
9. Go back and check the first star and see if it is drifting again. And then recheck the second star also. Keep repeating steps 4, 7 and 8, until there is no more drift in either of the stars you have chosen for a few minutes.

Your telescope is now drift aligned.

APPENDIX B: StarLock Utility

The StarLock Utility program provides the ability to:

- Install Firmware Updates
- StarLock Tracking Performance

Meade is constantly working to improve the performance of the product and it is common for new features or performance improvements in the software to be developed. Use the StarLock Utility to update your Starlock firmware.

If you use your telescope with a computer in the field, the StarLock utility will also allow you to monitor how your image session is going and help you tune the guide rate to optimize performance.

Installation

The StarLock utility will normally be installed when you install the Autostar Suite DVD that comes with your telescope. If you have download the program from Meade's website, the StarLock Utility program is packaged in an install file with a file name of the form StarLockUtilSetup_Vx.y.zip, where x and y are version and sub-version numbers. To install the program, download it to a working directory and execute the program. It will walk you through the setup.

Connection

In order to run the Utility program the StarLock needs to be attached to a Meade telescope by the StarLock interface cable connected to the "StarLock Telescope Connector" on the left side of the back of the StarLock. The telescope will need to be turned on to supply power to the StarLock. Next you need to attach a standard Meade AutoStar #507 telescope interface cable to the "PC" connector on the right side of rear of the StarLock. This cable is attached to a serial port on the back of your PC or via an USB/Serial connector.

Running The Software

From your Start Menu, click on Programs, Meade and then StarLockUtility to start the program. Alternatively, you can start the program from within AutostarSuite by selecting Telescope/StarLock Util.

When the program begins to execute, the dialog below will appear

Before beginning to use the program, check that the correct COMM port number is entered in the dialog



Fig 39: Start-up Screen

box, and if you have changed serial ports, click on the Reset Connection button on the display.

Viewing StarLock Images

To view StarLock images you should point your telescope at a bright or first magnitude star. It is best to start by focusing the wide field sensor. You can use the slow motion controls of the telescope to move the star the precise center of the sensor's field of view. The center of your optical field of view may not exactly match the sensor's field of view. For this exercise you want to center your star on the StarLock's center, not the eyepiece's. Once you have viewed the wide field sensor, you can then view the star in the narrow field sensor.

To view your StarLock images click on the Reset Connection button. Then, select which Imager you wish to view by clicking on the "Wide Field" or "Narrow Field" button. Now click on the "Focus" button. After a few seconds a "Downloading" progress message should appear on the bottom line of the display.

At this point you should see an image from the StarLock in the main window of the dialog. The sensors on the StarLock are 1280x1024 pixels. In order to speed the update process, the downloaded images are a maximum of 320x240 pixels. The "Binning" control allows you to select how many pixels of the original image are binned together to make the displayed image.

For example, binning 4x4 results in 16 pixels being combined into a single pixel of the final display and image size being 320x240. If you use a lower binning number, the image is cropped, showing you only the center 320x240 pixels of the resulting image.

It is therefore important that your target be as well

centered as possible as you switch between the wide field and narrow field images.

Additional controls that will be helpful are the “Exposure” control and the “Contrast” control. For most nighttime viewing the contrast control should be set about 2/3rds toward the right. For daylight viewing the contrast should be all the way to the left. This control allows you to look at only a subrange of an image. It is primarily for testing the StarLock using nighttime stars that may be very faint.

When viewing StarLock images, the location and intensity of brightest feature in the image are displayed below the image and updated each time the image is refreshed. It is important to adjust your exposure downward if your peak values are hitting 255.

Updating

The Utility program also has the ability to load new firmware into the StarLock. The firmware release code must first be downloaded from Meade’s website. It should be put in an easily located directory such as your desktop. The file will be named “StarLock_Vxy.Ldr”. To update the firmware, establish a serial connection with the StarLock by getting images to download by pressing the FOCUS button. Once you have a good connection, click the button again to stop focusing and then click the “Update” button. A file dialog similar to the one below will appear:

Navigate to the new firmware version and either double click on it, or select it and click on “Open.” The status bar at the bottom of the screen will show you the firmware being download. After the firmware has been successfully downloaded and checked for correctness, it will be burned into the StarLock. **DO NOT POWER OFF THE COMPUTER OR TELESCOPE DURING**

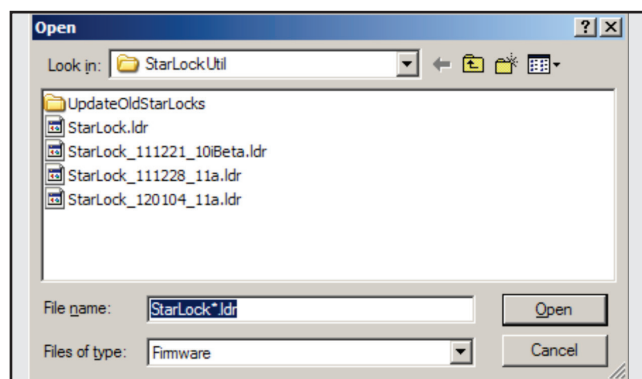

Fig 40: Update file dialog screen

THIS PROCESS. Once the new firmware has been successfully burned into the StarLock a message indicating the operation is complete will be posted on the bottom of the display.

NOTE: Close the StarLock Utility program and cycle the telescope power off and then on again to complete the update.

Monitoring StarLock Guiding

There are two different methods of monitoring StarLock guide performance. The first method is to look at the guiding history as a “Point Spread Function”. This presentation basically sums up the images of the guide star at each guide update cycle. It provides a good prediction of how well tracking is going and on the seeing conditions. To use this method, click on the PSF button.

The field of view of the display is approximately 20

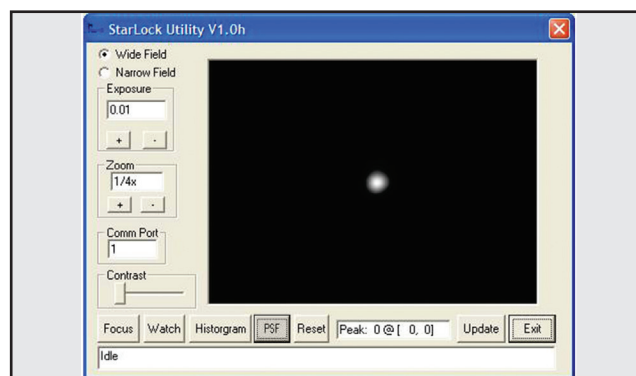

Fig 41: Monitoring StarLock — PSF button

arcseconds across. If your star is stretched horizontally, you are either not tracking aggressively enough, or you are tracking too aggressively. Change the Guide Rate setting under the StarLock menu on the telescope, reset the PSF and start a new measurement, if your star gets worse, change the Guide Rate in the other direction. Adjust your rate for best results with your seeing conditions.

In general, if seeing is poor, you will need to reduce your guide rate so you do not chase seeing. Under better conditions you can increase guide rates until over correction starts to make the scope jump back and forth across the star making it too wide again.

Histograms

The other way to monitor tracking is with the histogram function. This plots how many corrections are made at each distance. The result is typically a Gaussian distribution function. The plot will tell you about seeing and your alignment quality. To make this measurement click on the Histogram button.

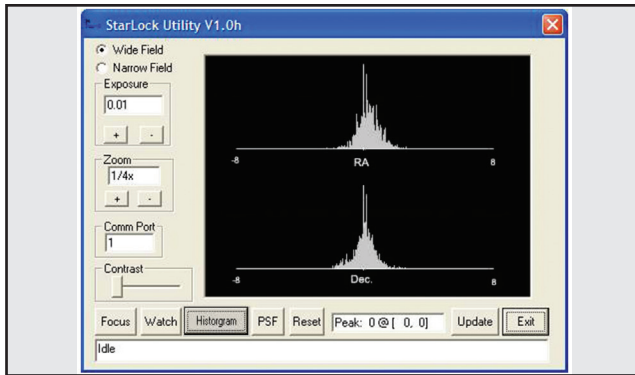

Fig 42: Typical Histogram

The example above is pretty typical. You can see that both the RA and DEC corrections are plotted in the range of -8 to $+8$ arcseconds. The width of the distribution is an indication of seeing conditions. In this case seeing is about $1/5$ to 2 arcminutes. Both distributions are pretty symmetric and centered on zero. This indicates a good telescope alignment.

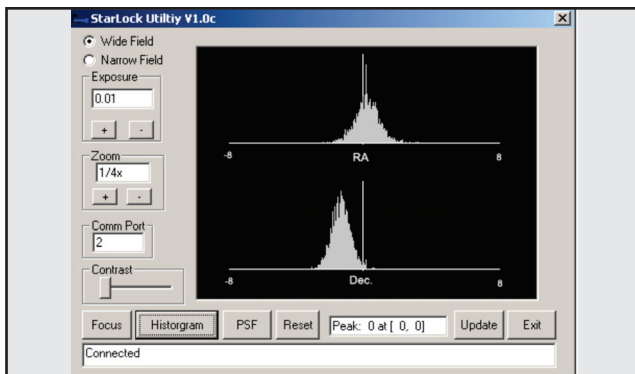

Fig 43: Poorly aligned telescope

The plot above tells you that the scope is not too well

aligned. Notice that the DEC guide corrections are not centered around zero. This is because the object is drifting down in declination due to the scope being poorly polar aligned. While the StarLock is succeeding in tracking the star, you will get field rotation over time due to scope misalignment and may not be able to point to targets near the poles. When you see this type of plot it is time to drift align, or realign your scope.

If you see an RA histogram with two humps, you are guiding too aggressively and need to reduce your guide rate.

APPENDIX C:

Automatic Rate Calibration (ARC)

Using StarLock's Automatic Rate Calibration (ARC) Feature

Obtaining best performance from StarLocked telescopes requires that the guiding aggressiveness be optimally set for current viewing/imaging conditions. A guide rate calibration routine has been included in the StarLock software that automatically determines the best rate based on viewing conditions. Calibrating your guide rate is a two-step process. First you will need to train and update the mount's Periodic Error Correction (PEC). Then you will run the Automatic Rate Calibration (ARC) routine. If you have already trained your mount's PEC you may go directly to running ARC.

Periodic Error Correction (PEC)

First set-up and align you scope. Now slew to a bright star near the celestial equator. Using your AutoStar II handbox, press the "7/Ret" key to bring up the **StarLock** menu and **Set RA Rate** and **Set Dec Rate** to 33%. Exit the **StarLock** menu by pressing MODE. Wait for the StarLock light to come on continuously to indicate that it has locked up on the star. At this point, simply go the hand box menus and select **Setup/Telescope/RA PEC/Train** and press **ENTER**. The StarLock will lock onto the current star and watch it for one worm revolution, about 6.4 minutes, and calibrate your drive's PEC. For even better PEC training, add one or more cycle's worth of data. Select **Setup/Telescope/RA PEC/Update** and the scope will then run one more 6.4 minute worm revolution, refining the PEC.

PEC training will be retained in the telescope's database and will not require retraining providing that you use the "Park" routine before turning the power off. The "Park" routine can be accessed through the "Utilities" menu in AutoStarII. PEC is retained even if you loosen the clutches, reposition the RA or DEC axis or disassemble and reassemble the telescope. Realignment will be required, but PEC training will not be required.

Automatic Rate Calibration (ARC)

Slew to a bright star near the celestial equator or you can use the same star that was used to train PEC.

Go to the **StarLock** Menu by pressing the "7" key. Then scroll down to **Auto Rate Cal**. The hand box will initially display **Test Dec 33%**. The percentage value will change about once a minute while it evaluates different rates. It will then display **Test RA 33%** and evaluate several rates. Finally, the scope will beep indicating calibration is complete and display the result on the hand box. Press the ENTER button to continue.

If you need to abort automatic calibration, just press the mode key. The process will stop and the default values will be used as the guide rate.

When to use Automatic Rate Calibration (ARC)

ARC calibration should be repeated at the start of an imaging session, if you have changed the optical tube assembly or if environmental conditions have significantly changed during an imaging session.

APPENDIX D:

LATITUDE CHART

Latitude Chart for Major Cities of the World

To aid in the polar alignment procedure, latitudes of major cities around the world are listed below. To determine the latitude of an observing site not listed on the chart, locate the city closest to your site. Then follow the procedure below:

Northern hemisphere observers (N): If the site is over 70 miles (110 km) North of the listed city, add one degree for every 70 miles. If the site is over 70 miles South of the listed city, subtract one degree per 70 miles.

Southern Hemisphere observers (S): If the site is over 70 miles (110 km) North of the listed city, subtract one degree for every 70 miles. If the site is over 70 miles South of the listed city, add one degree per 70 miles.

NORTH AMERICA

City	State/Prov./Country	Latitude
Albuquerque	New Mexico	35° N
Anchorage	Alaska	61° N
Atlanta	Georgia	34° N
Boston	Massachusetts	42° N
Calgary	Alberta	51° N
Chicago	Illinois	42° N
Cleveland	Ohio	41° N
Dallas	Texas	33° N
Denver	Colorado	40° N
Detroit	Michigan	42° N
Honolulu	Hawaii	21° N
Jackson	Mississippi	32° N
Kansas City	Missouri	39° N
Kenosha	Wisconsin	45° N
Las Vegas	Nevada	36° N
Little Rock	Arkansas	35° N
Los Angeles	California	34° N
Mexico City	Mexico	19° N
Miami	Florida	26° N
Minneapolis	Minnesota	45° N
Nashville	Tennessee	36° N
New Orleans	Louisiana	30° N
New York	New York	41° N
Oklahoma City	Oklahoma	35° N
Ottawa	Ontario	45° N
Philadelphia	Pennsylvania	40° N
Phoenix	Arizona	33° N
Portland	Oregon	46° N
Salt Lake City	Utah	41° N
San Antonio	Texas	29° N
San Diego	California	33° N
San Francisco	California	38° N
Seattle	Washington	47° N
Washington	District of Columbia	39° N

EUROPE

City	Country	Latitude
Amsterdam	Netherlands	52° N
Athens	Greece	38° N
Bern	Switzerland	47° N
Copenhagen	Denmark	56° N
Dublin	Ireland	53° N
Frankfurt	Germany	50° N
Glasgow	Scotland	56° N
Helsinki	Finland	60° N
Lisbon	Portugal	39° N
London	England	51° N
Madrid	Spain	40° N

EUROPE (continued)

City	Country	Latitude
Oslo	Norway	60° N
Paris	France	49° N
Rome	Italy	42° N
Stockholm	Sweden	59° N
Vienna	Austria	48° N
Warsaw	Poland	52° N

SOUTH AMERICA

City	Country	Latitude
Bogotá	Colombia	4° N
São Paulo	Brazil	23° S
Buenos Aires	Argentina	35° S
Montevideo	Uruguay	35° S
Santiago	Chile	34° S
Caracas	Venezuela	10° N

ASIA

City	Country	Latitude
Beijing	China	40° N
Hong Kong	China	23° N
Seoul	South Korea	37° N
Taipei	Taiwan	25° N
Tokyo	Japan	36° N
Sapporo	Japan	43° N
Bombay	India	19° N
Calcutta	India	22° N
Hanoi	Vietnam	21° N
Jedda	Saudi Arabia	21° N

AFRICA

City	Country	Latitude
Cairo	Egypt	30° N
Cape Town	South Africa	34° S
Rabat	Morocco	34° N
Tunis	Tunisia	37° N
Windhoek	Namibia	23° S

AUSTRALIA AND OCEANIA

City	State/Country	Latitude
Adelaide	South Australia	35° S
Brisbane	Queensland	27° S
Canberra	New South Wales	35° S
Alice Springs	Northern Territory	24° S
Hobart	Tasmania	43° S
Perth	Western Australia	32° S
Sydney	New South Wales	34° S
Melbourne	Victoria	38° S
Auckland	New Zealand	37° S

APPENDIX E: ADVANCED COMA-FREE OPTICAL SYSTEM

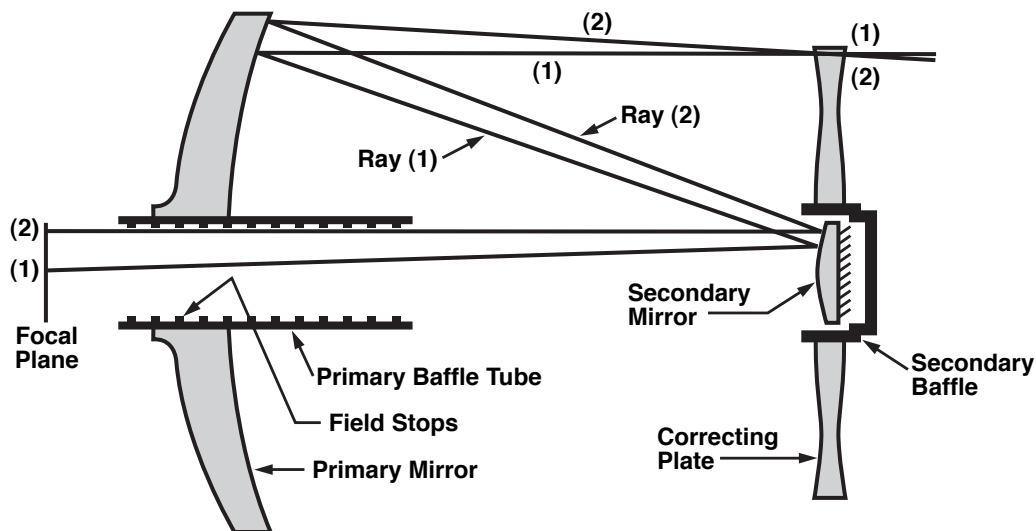

Unlike Schmidt-Cassegrain systems, Meade's Advanced Coma-Free (ACF) optical system provides razor-sharp pin-point star images all the way to the very edge of the field of view. This aplanatic (coma-free) optical system brings the highest level of performance to the amateur astronomer.

In the ACF design shown above, light enters from the right, passes through a thin lens with 2-sided aspheric correction ("correcting plate"), proceeds to a spherical primary mirror, and then to a hyperbolic secondary mirror. The hyperbolic secondary mirror multiplies the effective focal length of the primary mirror and results in a focus at the focal plane, with light passing through a central perforation in the primary mirror.

The Meade ACF optical system includes an oversized primary mirror, yielding a fully illuminated field-of-view significantly wider than is possible with a standard-size primary mirror. Note that light ray (2) in the figure would be lost entirely, except for the oversize primary. It is this phenomenon which results in Meade ACF having off-axis field illuminations about 10% greater, aperture-for-aperture, than other systems utilizing standard-size primary mirrors. Field stops machined into the inside-diameter surface of the primary mirror baffle tube significantly increase lunar, planetary, and deep-space image contrast. These field stops effectively block off-axis stray light rays.

APPENDIX F :

Initial Set-up: 12" and 14" ACF OTA's, Starlock and the StarLock Counterweight Set-up

The following provides guidelines for during your initial set-up of your 12" and 14" ACF LX850 Telescopes. These guidelines are meant only as a starting point, as you will need to fine tune the balance of your telescope depending on the equipment and accessories that you will be using.

Balancing the DEC Axis (ACF OTA Only)

Hold the optical tube so that it cannot accidentally swing freely. NOTE: An unbalanced OTA can swing quickly causing injury to the user. Position the RA axis parallel to the ground and tighten the RA locks. Position the OTA parallel to the ground. Unlock the DEC Clutches. The telescope now is able to move freely about the DEC axes.

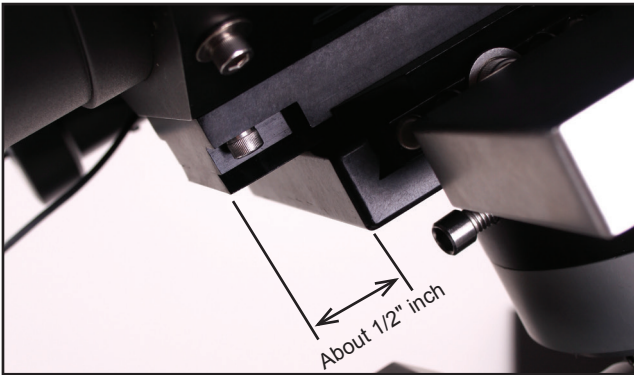

Fig 44: Start with 1/2" of the dovetail exposed.

Slightly loosen the OTA dovetail adapter lock knobs (Page 8, Fig. 29) so that the tube assembly slides easily back and forth in the dovetail mount. Be careful that the OTA does not fall out of the dovetail adapter! Start with 1/2" of the OTA dovetail plate extended out of the DEC Saddle (See Appendix E). Move the OTA assembly fore or aft, in the dovetail adapter until the telescope remains in horizontal position without tending to drift down in either direction. Once this is achieved tighten the OTA dovetail lock knobs firmly.

Positioning the StarLock assembly



Fig 45: Position StarLock flush with the receiver.

To position StarLock, loosen the two (2) retaining nuts at the side of dovetail adapter; position Starlock so that the back edge of the StarLock dovetail is flush with the lower edge of the saddle plate. Tighten to securely retain StarLock (Page 8, Fig. 42).

Positioning the StarLock counterweight

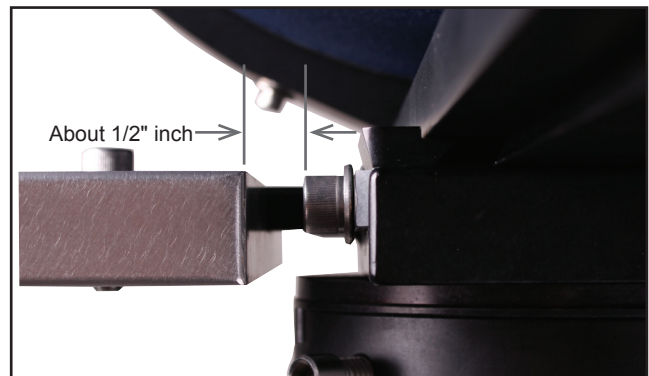

Fig 46: Gap of 1/2" between cap screw and weight.

To position the StarLock counter weight, loosen the retaining nut that attaches the weight to the saddle plate. Position StarLock counterweight so that there is a gap of about 1/2 of an inch between it and the adjacent cap screws that tighten the OTA to the saddle plate. Use this position when you begin to balance StarLock, as described on Page 20.

Notes

RECYCLING INFORMATION

(EU Countries only)

Correct Disposal of this Product



(Waste Electrical & Electronic Equipment)

This marking shown on the product or its literature indicates that it must not be disposed of in unsorted municipal waste at the end of its working life

To prevent possible harm to the environment or human health from uncontrolled waste disposal, please separate this from other types of wastes and recycle it as required by law. Household users should contact either the retailer where they purchased this product, or their local government office, for details of where and how they can take this item for environmentally safe recycling. Business users should contact their supplier and check the terms and conditions of the purchase contract

This product should not be mixed with other commercial wastes for disposal.

Notes

MEADE LIMITED WARRANTY

Every Meade telescope, spotting scope, and telescope accessory is warranted by Meade Instruments Corp. ("Meade") to be free of defects in materials and workmanship for a period of ONE YEAR from the date of original purchase in the U.S.A. and Canada. Meade will repair or replace a product, or part thereof, found by Meade to be defective, provided the defective part is returned to Meade, freight-prepaid, with proof of purchase. This warranty applies to the original purchaser only and is non-transferable. Meade products purchased outside North America are not included in this warranty, but are covered under separate warranties issued by Meade international distributors.

RGA Number Required: Prior to the return of any product or part, a Return Goods Authorization (RGA) number must be obtained from Meade by writing, or calling (800) 626-3233. Each returned part or product must include a written statement detailing the nature of the claimed defect, as well as the owner's name, address, and phone number.

This warranty is not valid in cases where the product has been abused or mishandled, where unauthorized repairs have been attempted or performed, or where depreciation of the product is due to normal wear-and-tear. Meade specifically disclaims special, indirect, or consequential damages or lost profit which may result from a breach of this warranty. Any implied warranties which cannot be disclaimed are hereby limited to a term of one year from the date of original retail purchase.

This warranty gives you specific rights. You may have other rights which vary from state to state.

Meade reserves the right to change product specifications or to discontinue products without notice.



MEADE®

27 Hubble, Irvine, California 92618
(800) 626-3233 ■ www.meade.com

14-9003-01 020113 Rev. 001